

Repair-Parts



Reactor 2 E-30 and E-XP2

Proportioning System

333024J
EN

Electric, Heated, Plural Component Proportioning System. For spraying polyurethane foam and polyurea coatings. For professional use only. Not approved for use in explosive atmospheres or hazardous locations.



Important Safety Instructions. Read all warnings and instructions in this manual. Save these instructions.

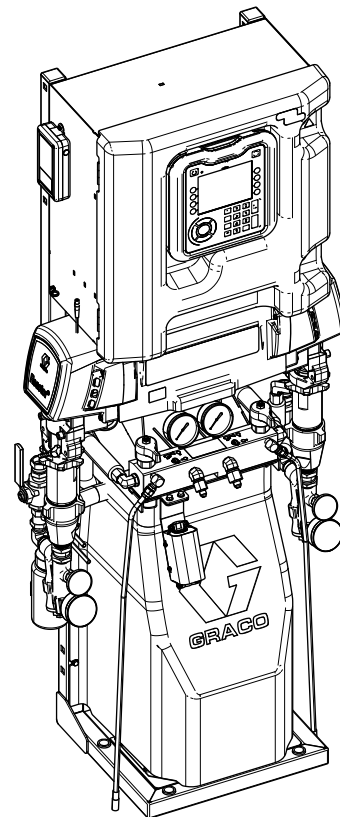

ti20577b





PROVEN QUALITY. LEADING TECHNOLOGY.











Contents





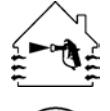



Warnings	3	Replace Pressure Transducers	59
Important Isocyanate Information	7	Replace Fans	60
Models	9	Repair Primary Heater	62
Approvals	11	Repair Heated Hose	66
Accessories	11	Repair Fluid Temperature Sensor (FTS)	68
Supplied Manuals	12	Replace Power Supply	71
Related Manuals	12	Replace Surge Protector	71
Troubleshooting	13	Replace Advanced Display Module (ADM)	71
Troubleshoot Errors	13	Replace Motor Control Module (MCM)	72
Pressure Relief Procedure	46	Software Update Procedure	72
Shutdown	47	Replace Temperature Control Module (TCM)	72
Flushing	49	Parts	73
Repair	50	Electrical Schematics	93
Before Beginning Repair	50	Reactor 2 Repair Spare Parts Reference	96
Flush Inlet Strainer Screen	50	Performance Charts	97
Change Pump Lubricant	51	Technical Specifications	100
Remove Pump	52	Notes	102
Install Pump	53	Graco Extended Warranty for Reactor® 2 Components	103
Repair Drive Housing	54		
Repair Electric Motor	57		
Repair Circuit Breaker Module	58		
Replace Fluid Inlet Sensor	59		

Warnings

The following warnings are for the setup, use, grounding, maintenance, and repair of this equipment. The exclamation point symbol alerts you to a general warning and the hazard symbols refer to procedure-specific risks. When these symbols appear in the body of this manual or on warning labels, refer back to these Warnings. Product-specific hazard symbols and warnings not covered in this section may appear throughout the body of this manual where applicable.

 <h2 style="margin: 0;">WARNING</h2>	
 	<p>ELECTRIC SHOCK HAZARD</p> <p>This equipment must be grounded. Improper grounding, setup, or usage of the system can cause electric shock.</p> <ul style="list-style-type: none"> • Turn off and disconnect power at main switch before disconnecting any cables and before servicing or installing equipment. • Connect only to grounded power source. • All electrical wiring must be done by a qualified electrician and comply with all local codes and regulations. • Do not expose to rain. Store indoors.
	<p>TOXIC FLUID OR FUMES</p> <p>Toxic fluids or fumes can cause serious injury or death if splashed in the eyes or on skin, inhaled or swallowed.</p> <ul style="list-style-type: none"> • Read Safety Data Sheet (SDS) for handling instructions and to know the specific hazards of the fluids you are using, including the effects of long-term exposure. • When spraying, servicing equipment, or when in the work area, always keep work area well ventilated and always wear appropriate personal protective equipment. See Personal Protective Equipment warnings in this manual. • Store hazardous fluid in approved containers, and dispose of it according to applicable guidelines.
	<p>PERSONAL PROTECTIVE EQUIPMENT</p> <p>Always wear appropriate personal protective equipment and cover all skin when spraying, servicing equipment, or when in the work area. Protective equipment helps prevent serious injury, including long-term exposure; inhalation of toxic fumes, mists or vapors; allergic reaction; burns; eye injury and hearing loss. This protective equipment includes but is not limited to:</p> <ul style="list-style-type: none"> • A properly fitting respirator, which may include a supplied-air respirator, chemically impermeable gloves, protective clothing and foot coverings as recommended by the fluid manufacturer and local regulatory authority. • Protective eyewear and hearing protection.

 <h1 style="margin: 0;">WARNING</h1>	
  	<p>SKIN INJECTION HAZARD</p> <p>High-pressure fluid from gun, hose leaks, or ruptured components will pierce skin. This may look like just a cut, but it is a serious injury that can result in amputation. Get immediate surgical treatment.</p> <ul style="list-style-type: none"> • Do not spray without tip guard and trigger guard installed. • Engage trigger lock when not spraying. • Do not point gun at anyone or at any part of the body. • Do not put your hand over the spray tip. • Do not stop or deflect leaks with your hand, body, glove, or rag. • Follow the Pressure Relief Procedure when you stop spraying and before cleaning, checking, or servicing equipment. • Tighten all fluid connections before operating the equipment. • Check hoses and couplings daily. Replace worn or damaged parts immediately.
   	<p>FIRE AND EXPLOSION HAZARD</p> <p>Flammable fumes, such as solvent and paint fumes, in work area can ignite or explode. To help prevent fire and explosion:</p> <ul style="list-style-type: none"> • Use equipment only in well ventilated area. • Eliminate all ignition sources; such as pilot lights, cigarettes, portable electric lamps, and plastic drop cloths (potential static arc). • Keep work area free of debris, including solvent, rags and gasoline. • Do not plug or unplug power cords, or turn power or light switches on or off when flammable fumes are present. • Ground all equipment in the work area. See Grounding instructions. • Use only grounded hoses. • Hold gun firmly to side of grounded pail when triggering into pail. Do not use pail liners unless they are antistatic or conductive. • Stop operation immediately if static sparking occurs or you feel a shock. Do not use equipment until you identify and correct the problem. • Keep a working fire extinguisher in the work area.
  	<p>THERMAL EXPANSION HAZARD</p> <p>Fluids subjected to heat in confined spaces, including hoses, can create a rapid rise in pressure due to the thermal expansion. Over-pressurization can result in equipment rupture and serious injury.</p> <ul style="list-style-type: none"> • Open a valve to relieve the fluid expansion during heating. • Replace hoses proactively at regular intervals based on your operating conditions.

 <h1 style="margin: 0;">WARNING</h1>	
	<p>PRESSURIZED ALUMINUM PARTS HAZARD</p> <p>Use of fluids that are incompatible with aluminum in pressurized equipment can cause serious chemical reaction and equipment rupture. Failure to follow this warning can result in death, serious injury, or property damage.</p> <ul style="list-style-type: none"> • Do not use 1,1,1-trichloroethane, methylene chloride, other halogenated hydrocarbon solvents or fluids containing such solvents. • Many other fluids may contain chemicals that can react with aluminum. Contact your material supplier for compatibility.
 	<p>PLASTIC PARTS CLEANING SOLVENT HAZARD</p> <p>Many solvents can degrade plastic parts and cause them to fail, which could cause serious injury or property damage.</p> <ul style="list-style-type: none"> • Use only compatible water-based solvents to clean plastic structural or pressure-containing parts. • See Technical Data in this and all other equipment instruction manuals. Read fluid and solvent manufacturer's MSDSs and recommendations.
 	<p>EQUIPMENT MISUSE HAZARD</p> <p>Misuse can cause death or serious injury.</p> <ul style="list-style-type: none"> • Do not operate the unit when fatigued or under the influence of drugs or alcohol. • Do not exceed the maximum working pressure or temperature rating of the lowest rated system component. See Technical Data in all equipment manuals. • Use fluids and solvents that are compatible with equipment wetted parts. See Technical Data in all equipment manuals. Read fluid and solvent manufacturer's warnings. For complete information about your material, request MSDS from distributor or retailer. • Do not leave the work area while equipment is energized or under pressure. • Turn off all equipment and follow the Pressure Relief Procedure when equipment is not in use. • Check equipment daily. Repair or replace worn or damaged parts immediately with genuine manufacturer's replacement parts only. • Do not alter or modify equipment. Alterations or modifications may void agency approvals and create safety hazards. • Make sure all equipment is rated and approved for the environment in which you are using it. • Use equipment only for its intended purpose. Call your distributor for information. • Route hoses and cables away from traffic areas, sharp edges, moving parts, and hot surfaces. • Do not kink or over bend hoses or use hoses to pull equipment. • Keep children and animals away from work area. • Comply with all applicable safety regulations.
 	<p>MOVING PARTS HAZARD</p> <p>Moving parts can pinch, cut or amputate fingers and other body parts.</p> <ul style="list-style-type: none"> • Keep clear of moving parts. • Do not operate equipment with protective guards or covers removed. • Pressurized equipment can start without warning. Before checking, moving, or servicing equipment, follow the Pressure Relief Procedure and disconnect all power sources.



WARNING



BURN HAZARD

Equipment surfaces and fluid that is heated can become very hot during operation. To avoid severe burns:

- Do not touch hot fluid or equipment.

Important Isocyanate Information

Isocyanates (ISO) are catalysts used in two component materials.

Isocyanate Conditions

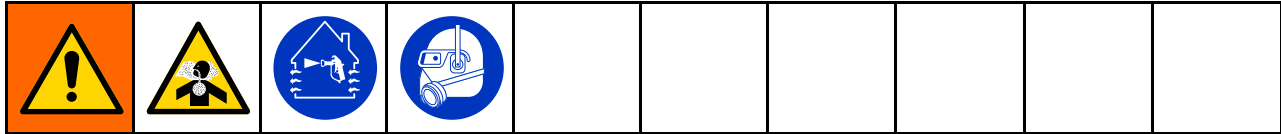

Spraying or dispensing fluids that contain isocyanates creates potentially harmful mists, vapors, and atomized particulates.



- Read and understand the fluid manufacturer’s warnings and Safety Data Sheet (SDS) to know specific hazards and precautions related to isocyanates.
- Use of isocyanates involves potentially hazardous procedures. Do not spray with this equipment unless you are trained, qualified, and have read and understood the information in this manual and in the fluid manufacturer’s application instructions and SDS.
- Use of incorrectly maintained or mis-adjusted equipment may result in improperly cured material, which could cause off gassing and offensive odors. Equipment must be carefully maintained and adjusted according to instructions in the manual.
- To prevent inhalation of isocyanate mists, vapors and atomized particulates, everyone in the work area must wear appropriate respiratory protection. Always wear a properly fitting respirator, which may include a supplied-air respirator. Ventilate the work area according to instructions in the fluid manufacturer’s SDS.
- Avoid all skin contact with isocyanates. Everyone in the work area must wear chemically impermeable gloves, protective clothing and foot coverings as recommended by the fluid manufacturer and local regulatory authority. Follow all fluid manufacturer recommendations, including those regarding handling of contaminated clothing. After spraying, wash hands and face before eating or drinking.
- Hazard from exposure to isocyanates continues after spraying. Anyone without appropriate personal protective equipment must stay out of the work area during application and after application for the time period specified by the fluid manufacturer. Generally this time period is at least 24 hours.
- Warn others who may enter work area of hazard from exposure to isocyanates. Follow the recommendations of the fluid manufacturer and local regulatory authority. Posting a placard such as the following outside the work area is recommended:



Material Self-Ignition

				
Some materials may become self-igniting if applied too thick. Read material manufacturer's warnings and SDS.				

Keep Components A and B Separate

				
Cross-contamination can result in cured material in fluid lines which could cause serious injury or damage to equipment. To prevent cross-contamination:				
<ul style="list-style-type: none"> • Never interchange component A and component B wetted parts. • Never use solvent on one side if it has been contaminated from the other side. 				

Changing Materials

NOTICE				
Changing the material types used in your equipment requires special attention to avoid equipment damage and downtime.				
<ul style="list-style-type: none"> • When changing materials, flush the equipment multiple times to ensure it is thoroughly clean. • Always clean the fluid inlet strainers after flushing. • Check with your material manufacturer for chemical compatibility. • When changing between epoxies and urethanes or polyureas, disassemble and clean all fluid components and change hoses. Epoxies often have amines on the B (hardener) side. Polyureas often have amines on the B (resin) side. 				

Moisture Sensitivity of Isocyanates

Exposure to moisture (such as humidity) will cause ISO to partially cure, forming small, hard, abrasive crystals that become suspended in the fluid. Eventually a film will form on the surface and the ISO will begin to gel, increasing in viscosity.

NOTICE				
Partially cured ISO will reduce performance and the life of all wetted parts.				
<ul style="list-style-type: none"> • Always use a sealed container with a desiccant dryer in the vent, or a nitrogen atmosphere. Never store ISO in an open container. • Keep the ISO pump wet cup or reservoir (if installed) filled with appropriate lubricant. The lubricant creates a barrier between the ISO and the atmosphere. • Use only moisture-proof hoses compatible with ISO. • Never use reclaimed solvents, which may contain moisture. Always keep solvent containers closed when not in use. • Always lubricate threaded parts with an appropriate lubricant when reassembling. 				

NOTE: The amount of film formation and rate of crystallization varies depending on the blend of ISO, the humidity, and the temperature.

Foam Resins with 245 fa Blowing Agents

Some foam blowing agents will froth at temperatures above 90°F (33°C) when not under pressure, especially if agitated. To reduce frothing, minimize preheating in a circulation system.

Models

Reactor 2 E-30 and E-30 Elite

All elite systems include fluid inlet pressure and temperature sensors, Graco InSite™, and Xtreme-Wrap 50 ft (15 m) head hose. For part numbers, see [Accessories, page 11](#)

Model	E-30 Model						E-30 Elite Model					
	10 kW			15 kW			10 kW			15kW		
Proportioner ★	272010			272011			272110			272111		
Maximum Fluid Working Pressure psi (MPa, bar)	2000 (14, 140)			2000 (14, 140)			2000 (14, 140)			2000 (14, 140)		
Approximate Output per Cycle (A+B) gal. (liter)	0.0272 (0.1034)			0.0272 (0.1034)			0.0272 (0.1034)			0.0272 (0.1034)		
Max Flow Rate lb/min (kg/min)	30 (13.5)			30 (13.5)			30 (13.5)			30 (13.5)		
Total System Load † ◆(Watts)	17,900			23,000			17,900			23,000		
Configurable Voltage Phase◆	200– 240 VAC 1Ø	200– 240 VAC 3ØΔ	350– 415 VAC 3ØY	200– 240 VAC 1Ø	200– 240 VAC 3ØΔ	350– 415 VAC 3ØY	200– 240 VAC 1Ø	200– 240 VAC 3ØΔ	350– 415 VAC 3ØY	200– 240 VAC 1Ø	200– 240 VAC 3ØΔ	350– 415 VAC 3ØY
Full Load Peak Current*	78	50	34	100	62	35	78	50	34	100	62	35

Fusion AP Package ✖ (Gun Part No.)	AP2010 (246102)	AH2010 (246102)	AP2011 (246102)	AH2011 (246102)	AP2110 (246102)	AH2110 (246102)	AP2111 (246102)	AH2111 (246102)
Fusion CS Package ✖ (Gun Part No.)	CS2010 (CS02RD)	CH2010 (CS02RD)	CS2011 (CS02RD)	CH2011 (CS02RD)	CS2110 (CS02RD)	CH2110 (CS02RD)	CS2111 (CS02RD)	CH2111 (CS02RD)
Probler P2 Package ✖ (Gun Part No.)	P22010 (GCP2R2)	PH2010 (GCP2R2)	P22011 (GCP2R2)	PH2011 (GCP2R2)	P22110 (GCP2R2)	PH2110 (GCP2R2)	P22111 (GCP2R2)	PH2111 (GCP2R2)
Heated Hose 50 ft (15 m)	24K240	24K240	24K240	24K240	24Y240	24Y240	24Y240	24Y240
24K240 (scuff guard) 24Y240 (Xtreme-Wrap)	Qty: 1	Qty: 5	Qty: 1	Qty: 5	Qty: 1	Qty: 5	Qty: 1	Qty: 5
Heated Whip Hose 10 ft (3 m)	246050		246050		246050		246050	
Graco Insite™					✓		✓	
Fluid Inlet Sensors (2)					✓		✓	

* Full load amps with all devices operating at maximum capabilities. Fuse requirements at various flow rates and mix chamber sizes may be less.

† Total system watts used by system, based on maximum heated hose length for each unit.

- E-30 and E-XP2 series: 310 ft (94.5 m) maximum heated hose length, including whip hose.

★ See [Approvals, page 11](#).

✖ Packages include gun, heated hose, and whip hose. Elite packages also include Graco InSite and fluid inlet sensors.

◆ Low line input voltage will reduce power available and heaters will not perform at full capacity.

Voltage Configurations Key	
Ø	Phase
Δ	DELTA
Y	WYE

Reactor 2 E-XP2 and E-XP2 Elite

All elite systems include fluid inlet pressure and temperature sensors, Graco InSite™, and Xtreme-Wrap 50 ft (15 m) head hose. For part numbers, see [Accessories, page 11](#)

Model	E-XP2 Model			E-XP2 Elite Model		
	15 kW			15 kW		
Proportioner ★	272012			272112		
Maximum Fluid Working Pressure psi (MPa, bar)	3500 (24.1, 241)			3500 (24.1, 241)		
Approximate Output per Cycle (A+B) gal. (liter)	0.0203 (0.0771)			0.0203 (0.0771)		
Max Flow Rate gpm/min (l/min)	2 (7.6)			2 (7.6)		
Total System Load † ◆ (Watts)	23,000			23,000		
Configurable Voltage Phase ◆	200–240 VAC 1Ø	200–240 VAC 3ØΔ	350–415 VAC 3ØY	200–240 VAC 1Ø	200–240 VAC 3ØΔ	350–415 VAC 3ØY
Full Load Peak Current (amps)*	100	62	35	100	62	35
Fusion AP Package ✖ (Gun Part No.)	AP2012 (246100)			AP2112 (246100)		
Probler P2 Package ✖ (Gun Part No.)	P22012 (GCP2R0)			P22112 (GCP2R0)		
Heated Hose 50 ft (15 m)	24K241 (scuff guard)			24Y241 (Xtreme-Wrap)		
Heated Whip Hose 10 ft (3 m)	246055			246055		
Graco InSite™				✓		
Fluid Inlet Sensors (2)				✓		

* Full load amps with all devices operating at maximum capabilities. Fuse requirements at various flow rates and mix chamber sizes may be less.

† Total system watts used by system, based on maximum heated hose length for each unit.

- E-30 and E-XP2 series: 310 ft (94.5 m) maximum heated hose length, including whip hose.

★ See [Approvals, page 11](#).

✖ Packages include gun, heated hose, and whip hose. Elite packages also include Graco InSite and fluid inlet sensors.

◆ Low line input voltage will reduce power available and heaters will not perform at full capacity.

Voltage Configurations Key	
Ø	Phase
Δ	DELTA
Y	WYE

Approvals

Intertek approvals apply to proportioners without hoses.

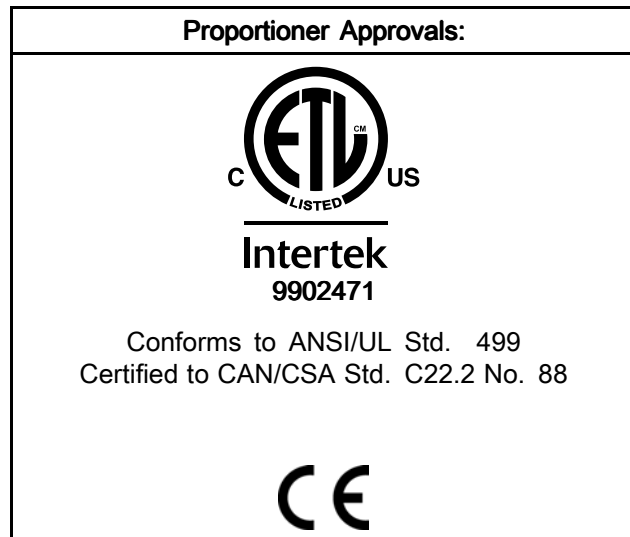

Accessories

Kit Number	Description
24U315	Air Manifold Kit (4 outlets)
24U314	Wheel and Handle Kit
24T280	Graco InSite Kit
16X521	Graco InSite Extension cable 24.6 ft (7.5 m)
24N449	50 ft (15 m) CAN cable (for remote display module)
24K207	Fluid Temperature Sensor (FTS) with RTD
24U174	Remote Display Module Kit
24K337	Light Tower Kit
15V551	ADM Protective Covers (10 pack)
15M483	Remote Display Module Protective Covers (10 pack)
24M174	Drum Level Sticks
121006	150 ft (45 m) CAN cable (for remote display module)
24N365	RTD Test Cables (to aide resistance measurements)

Supplied Manuals

The following manuals are shipped with the Reactor 2. Refer to these manuals for detailed equipment information.

Manuals are also available at www.graco.com.

Manual	Description
333023	Reactor 2 E-30 and E-XP2 Operation
333091	Reactor 2 E-30 and E-XP2 Startup Quick Guide
333092	Reactor 2 E-30 and E-XP2 Shutdown Quick Guide

Related Manuals

The following manuals are for accessories used with the Reactor.

Component Manuals in English:

Manuals are available at www.graco.com.

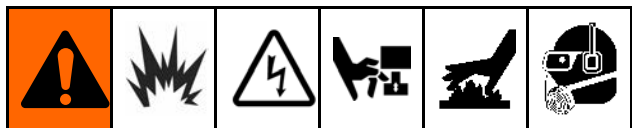

System Manuals	
333023	Reactor 2 E-30 and E-XP2 Operation
Displacement Pump Manual	
309577	Electric Reactor Displacement Pump, Repair-Parts
Feed System Manuals	
309572	Heated Hose, Instructions-Parts
309852	Circulation and Return Tube Kit, Instructions-Parts
309815	Feed Pump Kits, Instructions-Parts
309827	Feed Pump Air Supply Kit, Instructions-Parts
Spray Gun Manuals	
309550	Fusion™ AP Gun
312666	Fusion™ CS Gun
313213	Probler® P2 Gun
Accessory Manuals	
3A1905	Feed Pump Shutdown Kit, Instructions-Parts
3A1906	Light Tower Kit, Instructions-Parts
3A1907	Remote Display Module Kit, Instructions-Parts
332735	Air Manifold Kit, Instructions-Parts
332736	Handle and Wheel Kit, Instructions-Parts
333276	Graco InSite™ Kit, Instructions-Parts

Troubleshooting



Troubleshoot Errors

There are three types of errors that can occur. Errors are indicated on the display as well as by the light tower (optional).

Error	Description
Alarms 	A parameter critical to the process has reached a level requiring the system to stop. The alarm needs to be addressed immediately.
Deviations 	A parameter critical to the process has reached a level requiring attention, but not sufficient enough to stop the system at this time.
Advisories 	A parameter that is not immediately critical to the process. The advisory needs attention to prevent more serious issues in the future.

See [Error Codes, page 13](#) for causes and solutions to each error code.

To troubleshoot the error:

Error Codes

Note

When an error occurs be sure to determine the code before resetting it. If you forget which error code occurred, see the Errors screen to view the last 200 errors, with date, time, and description.

1. Press the soft key for help with the active error.

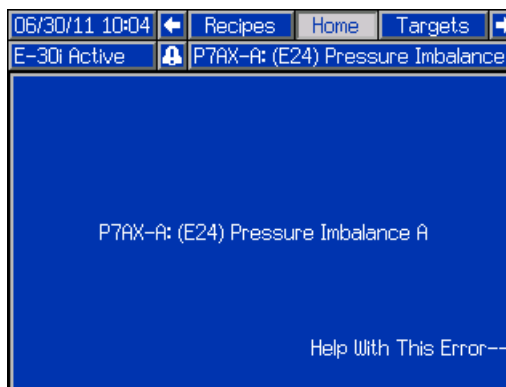

Note





Press  or  to return to the previously displayed screen.





2. The QR code screen will be displayed. Scan the QR code with your smartphone to be sent directly to online troubleshooting for the active error code. Otherwise, manually navigate to <http://help.graco.com> and search for the active error.







3. If no internet connection is available, see [Error Codes, page 13](#) for causes and solutions for each error code.



Troubleshooting

Error	Location	Type	Description	Cause	Solution
A1NM	MCM		Low Motor Current	Loose/broken connection.	Check for loose wire terminations at MCM motor connector.
				Bad Motor.	Disconnect motor output connector from MCM. Confirm less than 8 ohms resistance between each pair of motor power leads (M1 to M2, M1 to M3, M2 to M3). If any readings greater than 8 ohms, check motor wiring for damage and/or loose terminations.
A4DA	Heater A		High Current A	Short circuit in heater wiring.	Check wiring for touching wires.
				Bad Heater.	Confirm resistance of heater. Heater resistance should be 18–21 Ω for each heater element, 9–12 Ω combined for 10 kW systems, and 6-8 Ω for 15 kW systems. If out of tolerance, replace heater element.
A4DB	Heater B		High Current B	Short circuit in heater wiring.	Check wiring for touching wires.
				Bad Heater.	Confirm resistance of heater. Heater resistance should be 9-12 Ω for 10 kW systems and 6-8 Ω for 15 kW systems. If out of tolerance, replace heater.
A4DH	Hose		High Current Hose	Short circuit in hose wiring.	Check continuity of transformer windings. Normal readings are about 0.2Ω on both primary and secondary. If reading is 0Ω replace transformer.
					Check for shorts between the primary winding and the support frame or enclosure.

Error	Location	Type	Description	Cause	Solution
A4NM	MCM		High Motor Current	Short circuit of motor wiring.	Check wiring to the motor to ensure no bare wires are touching and that no wires are shorted to ground.
				Motor will not rotate.	Remove pump gear housings from motor and check that motor shaft rotates freely in direction indicated on motor housing.
				Damaged gear train.	Check pump gear trains for damage and repair or replace as necessary.
				Chemical pump is stuck.	Repair or replace chemical pump.
A7DA	Heater A		Unexpected Current A	Shorted TCM	If error cannot be cleared or regenerates consistently, replace module.
A7DB	Heater B		Unexpected Current B	Shorted TCM	If error cannot be cleared or regenerates consistently, replace module.
A7DH	Hose		Unexpected Current Hose	Shorted TCM	If error cannot be cleared or regenerates consistently, replace module.











Troubleshooting

Error	Location	Type	Description	Cause	Solution
A8DA	Heater A		No Current A	Tripped circuit breaker.	Visually check circuit breaker for a tripped condition.
				Loose/broken connection.	Check heater wiring for loose wires.
A8DB	Heater B		No Current B	Tripped circuit breaker.	Visually check circuit breaker for a tripped condition.
				Loose/broken connection.	Check heater wiring for loose wires.
A8DH	Hose		No Current Hose	Tripped circuit breaker.	Visually check circuit breaker for a tripped condition.
				Loose/broken connection.	Check heater wiring for loose wires.
CACM	MCM		MCM Communication Error	Module does not have software.	Insert a system token into the ADM module and cycle the power. Wait until the upload is complete before removing the token.
				Dial set to wrong position.	Ensure the MCM dial is set to the correct position: 2 for E-30, 3 for E-XP2
				No 24 VDC supply to module.	Green light on each module should be lit. If green light is not lit, check to make sure each CAN cable connection is tight. Verify the power supply is outputting 24 VDC. If not, check power supply wiring. If wiring is okay, replace the power supply.
				Loose or broken CAN cable.	Check the CAN cables running between GCA modules and tighten if needed. If the problem still persists move each cable around the connector and watch the flashing yellow light on the GCA modules. If the yellow light stops flashing, replace the CAN cable.





Error	Location	Type	Description	Cause	Solution
CACT	TCM		TCM Communication Error	Module does not have software.	Insert a system token into the ADM module and cycle the power. Wait until the upload is complete before removing the token.
				No 24 VDC supply to module.	Green light on each module should be lit. If green light is not lit, check to make sure each CAN cable connection is tight. Verify the power supply is outputting 24 VDC. If not, check power supply wiring. If wiring is okay, replace the power supply.
				Loose or broken CAN cable.	Check the CAN cables running between GCA modules and tighten if needed. If the problem still persists move each cable around the connector and watch the flashing yellow light on the GCA modules. If the yellow light stops flashing, replace the CAN cable.
DADX	MCM		Pump Runaway	Flow rate is too large.	Mix chamber too large for system selected. Use mix chamber rated for system.
					Ensure the system has chemical and the feed pumps are operating correctly.
					No material in pumps. Verify pumps are supplying chemical. If necessary, replace or refill drums.
					Inlet ball valves are closed. Open ball valves.





Troubleshooting

Error	Location	Type	Description	Cause	Solution
DE0X	MCM		Cycle Switch Error	Faulty or missing cycle switch.	Check wiring between cycle switch and MCM, Port 12.
				Switch disconnected	Measure resistance between pin 3 and 4 at connector. Normal resistance is 0.10 ohms.
				Missing or out of place cycle switch magnet.	Check presence and position of cycle switch magnet on output crank arm.



Error	Location	Type	Description	Cause	Solution
EVCH	ADM		Manual Hose Mode Enabled	Manual hose mode has been enabled in System Setup screen.	Install a functioning fluid temperature sensor (FTS) on the hose. Manual hose mode will automatically turn off.
EAUX	ADM		USB Busy	USB drive has been inserted to the ADM.	Do not remove USB drive until download/upload is complete.
EVUX	ADM		USB disabled	USB download/uploads are disabled.	Enable USB download/uploads on the Advanced Setup screen before inserting a USB drive.
F9DX	MCM		High Pressure/Flow Cutback	Mix chamber is too large for set pressure.	Reference the pressure flow curves and select a tip size that is the correct size for the set pressure.
H2MA	Heater A		Low Frequency A	Line frequency is below 45 Hz	Ensure line frequency of incoming power is between 45 and 65 Hz.
H2MB	Heater B		Low Frequency B	Line frequency is below 45 Hz	Ensure line frequency of incoming power is between 45 and 65 Hz.
H2MH	Hose		Low Frequency Hose	Line frequency is below 45 Hz	Ensure line frequency of incoming power is between 45 and 65 Hz.
H3MA	Heater A		High Frequency A	Line frequency is above 65 Hz	Ensure line frequency of incoming power is between 45 and 65 Hz.
H3MB	Heater B		High Frequency B	Line frequency is above 65 Hz	Ensure line frequency of incoming power is between 45 and 65 Hz.
H3MH	Hose		High Frequency Hose	Line frequency is above 65 Hz	Ensure line frequency of incoming power is between 45 and 65 Hz.
K8NM	MCM		Locked Rotor Motor	Motor will not rotate.	Remove pump gear housings from motor and check that motor shaft rotates freely in direction indicated on motor housing.
				Damaged gear train.	Check motor/pump gear trains for damage and repair or replace as necessary.
				Chemical pump is stuck.	Repair or replace chemical pump.



Troubleshooting

Error	Location	Type	Description	Cause	Solution
L1AX	ADM		Low Chemical Level A	Low material level.	Refill material and update drum level on ADM Maintenance screen. Alarm can be disabled on the System Setup screen.
L1BX	ADM		Low Chemical Level B	Low material level.	Refill material and update drum level on ADM Maintenance screen. Alarm can be disabled on the System Setup screen.
MMUX	USB		Maintenance Due - USB	USB logs have reached a level where data loss will occur if logs are not downloaded.	Insert a USB drive into the ADM and download all logs.
P0AX	MCM		Pressure Imbalance A High	Pressure difference between A and B material is greater than the defined value.	Ensure material flow is equally restricted on both material lines.
				Pressure imbalance is defined too low.	Ensure that the pressure imbalance value, on the System Setup screen, is at an acceptable maximum pressure to prevent unnecessary alarms and abort dispenses.
				Out of material.	Fill tanks with material
				Fluid leaking from heater inlet rupture disk.	Check if heater and PRESSURE RELIEF/SPRAY valve are plugged. Clear. Replace rupture disk. Do not replace with a pipe plug.
				Feed system defective.	Check feed pump and hoses for blockage. Check that feed pumps have correct air pressure.



Error	Location	Type	Description	Cause	Solution
P0BX	MCM		Pressure Imbalance B High	Pressure difference between A and B material is greater than the defined value.	Ensure material flow is equally restricted on both material lines.
				Pressure imbalance is defined too low.	Ensure that the pressure imbalance value, on the System Setup screen, is at an acceptable maximum pressure to prevent unnecessary alarms and abort dispenses.
				Out of material.	Fill tanks with material
				Fluid leaking from heater inlet rupture disk.	Check if heater and PRESSURE RELIEF/SPRAY valve are plugged. Clear. Replace rupture disk. Do not replace with a pipe plug.
				Feed system defective.	Check feed pump and hoses for blockage. Check that feed pumps have correct air pressure.
P1FA	MCM		Low Inlet Pressure A	Inlet pressure lower than defined value.	Ensure that inlet pressure to the pump is sufficient.
				Value defined too high.	Ensure that the low pressure alarm level defined on the System Setup screen is acceptable.
P1FB	MCM		Low Inlet Pressure B	Inlet pressure lower than defined value.	Ensure that inlet pressure to the pump is sufficient.
				Value defined too high.	Ensure that the low pressure alarm level defined on the System Setup screen is acceptable.
P2FA	MCM		Low Inlet Pressure A	Inlet pressure lower than defined value.	Ensure that inlet pressure to the pump is sufficient.
				Value defined too high.	Ensure that the low pressure alarm level defined on the System Setup screen is acceptable.



Troubleshooting

Error	Location	Type	Description	Cause	Solution
P2FB	MCM		Low Inlet Pressure B	Inlet pressure lower than defined value.	Ensure that inlet pressure to the pump is sufficient.
				Value defined too high.	Ensure that the low pressure alarm level defined on the System Setup screen is acceptable.
P4AX	MCM		High Pressure A	System pressurized before allowing heat to reach setpoint.	Pressure in the hose and pumps will increase as the system heats up. Turn on heat and allow all zones to reach the temperature setpoint before turning on the pumps.
				Bad pressure transducer.	Verify the ADM pressure reading and the analog gauges at the manifold.
				E-XP2 system configured as E-30.	Alarm level is lower for E-30 than for E-XP2. Ensure dial on MCM is set to position "3" for E-XP2.
P4BX	MCM		High Pressure B	System pressurized before allowing heat to reach setpoint.	Pressure in the hose and pumps will increase as the system heats up. Turn on heat and allow all zones to reach the temperature setpoint before turning on the pumps.
				Bad pressure transducer.	Verify the ADM pressure reading and the analog gauges at the manifold.
				E-XP2 system configured as E-30.	Alarm level is lower for E-30 than for E-XP2. Ensure dial on MCM is set to position "3" for E-XP2.





Error	Location	Type	Description	Cause	Solution
P6AX	MCM		Pressure Sensor Error A	Loose/bad connection.	Check to ensure the pressure transducer is properly installed and all wires are properly connected.
				Bad sensor.	Check if the error follows the transducer. Disconnect transducer cables from the MCM (connectors 6 and 7). Reverse A and B connections and check if the errors follows. If the error follows the transducer, replace the pressure transducer.
P6BX	MCM		Pressure Sensor Error B	Loose/bad connection.	Check to ensure the pressure transducer is properly installed and all wires are properly connected.
				Bad sensor.	Check if the error follows the transducer. Disconnect transducer cables from the MCM (connectors 6 and 7). Reverse A and B connections and check if the errors follows. If the error follows the transducer, replace the pressure transducer.
P6FA	MCM		Pressure Sensor Error Inlet A	Inlet sensors not installed.	If inlet sensors are not installed, inlet sensors should be disabled on the System Setup screen.
				Loose/bad connection.	Check to ensure inlet sensor is properly installed and all wires are properly connected.
				Bad sensor.	Check if the error follows the inlet sensor. Disconnect inlet sensor cables from the MCM (connectors 8 and 9). Reverse A and B connections and check if the errors follows. If the error follows the sensor, replace the inlet sensor.





Troubleshooting

Error	Location	Type	Description	Cause	Solution
P6FB	MCM		Pressure Sensor Error Inlet B	Inlet sensors not installed.	If inlet sensors are not installed, inlet sensors should be disabled on the System Setup screen.
				Loose/bad connection.	Check to ensure inlet sensor is properly installed and all wires are properly connected.
				Bad sensor.	Check if the error follows the inlet sensor. Disconnect inlet sensor cables from the MCM (connectors 8 and 9). Reverse A and B connections and check if the errors follows. If the error follows the sensor, replace the inlet sensor.
P7AX	MCM		Pressure Imbalance A High	Pressure difference between A and B material is greater than the defined value.	Ensure material flow is equally restricted on both material lines.
				Pressure imbalance is defined too low.	Ensure that the pressure imbalance value, on the System Setup screen, is at an acceptable maximum pressure to prevent unnecessary alarms and abort dispenses.
				Out of material.	Fill tanks with material
				Fluid leaking from heater inlet rupture disk.	Check if heater and PRESSURE RELIEF/SPRAY valve are plugged. Clear. Replace rupture disk. Do not replace with a pipe plug.
				Feed system defective.	Check feed pump and hoses for blockage. Check that feed pumps have correct air pressure.



Error	Location	Type	Description	Cause	Solution
P7BX	MCM		Pressure Imbalance B High	Pressure difference between A and B material is greater than the defined value.	Ensure material flow is equally restricted on both material lines.
				Pressure imbalance is defined too low.	Ensure that the pressure imbalance value, on the System Setup screen, is at an acceptable maximum pressure to prevent unnecessary alarms and abort dispenses.
				Out of material.	Fill tanks with material
				Fluid leaking from heater inlet rupture disk.	Check if heater and PRESSURE RELIEF/SPRAY valve are plugged. Clear. Replace rupture disk. Do not replace with a pipe plug.
				Feed system defective.	Check feed pump and hoses for blockage. Check that feed pumps have correct air pressure.
T2DA	Heater A		Low Temperature A	Flow is too high at current setpoint.	Use a smaller mix chamber that is rated for the unit in use. If recirculating, decrease flow or decrease temperature setpoint.
				Bad RTD or bad RTD placement against heater.	Swap A and B heater output cables and RTD cables and see if issue follows. If so, replace RTD.
				Bad heater rod or loose heater wire.	Confirm resistance of heater. Heater resistance should be 9-12 Ω for 10 kW systems and 6-8 Ω for 15 kW systems. If out of tolerance, check for loose heater rod wire(s). Reconnect wires or replace heater rod if necessary.



Troubleshooting



Error	Location	Type	Description	Cause	Solution
T2DB	Heater B		Low Temperature B	Flow is too high at current setpoint.	Use a smaller mix chamber that is rated for the unit in use. If recirculating, decrease flow or decrease temperature setpoint.
				Bad RTD or bad RTD placement against heater.	Swap A and B heater output cables and RTD cables and see if issue follows. If so, replace RTD.
				Bad heater rod or loose heater wire.	Confirm resistance of heater. Heater resistance should be 9-12 Ω for 10 kW systems and 6-8 Ω for 15 kW systems. If out of tolerance, check for loose heater rod wire(s). Reconnect wires or replace heater rod if necessary.
T2DH	Hose		Low Temperature Hose	Flow is too high at current setpoint.	Use a smaller mix chamber that is rated for the unit in use. If recirculating, decrease flow or decrease temperature setpoint.
				Cold chemical in unheated portion of system passed hose FTS at startup.	Recirculate heated chemical back to drum in cold conditions before startup.
T2FA	MCM		Low Temperature Inlet A	Inlet fluid temperature is below the defined level.	Recirculate fluid through heaters until inlet fluid temperature is above defined error level.
					Increase the low temperature deviation level on the System Setup screen.
T2FB	MCM		Low Temperature Inlet B	Inlet fluid temperature is below the defined level.	Recirculate fluid through heaters until inlet fluid temperature is above defined error level.
					Increase the low temperature deviation level on the System Setup screen.

Error	Location	Type	Description	Cause	Solution
T3CH	Hose		Hose Cutback	Hose current has been reduced because hose has been drawing current for an extended period.	Hose setpoint higher than A and B setpoints. Decrease hose setpoint.
					Hose FTS is in a colder environment than the rest of the hose. Expose FTS to the same environment as the rest of the hose.
T3CT	TCM		TCM Cutback	High ambient temperature.	Ensure ambient temperature is below 120°F(48°C) before using the system.
				Enclosure fan not operating.	Ensure fan in electrical enclosure is spinning. If it is not, check fan wiring or replace fan.
				Module fan not operating.	If a TCM fan error (WMIO) has occurred, fan inside the module is not working properly. Check TCM fan for debris and clear with forced air if necessary.
T3NM	MCM		Motor Temperature Cutback	Motor is operating outside of the pressure flow curve.	The system is running at a lower setpoint to preserve motor life. Run the system at a lower duty cycle or with a smaller mix chamber.
				High ambient temperature	Ensure ambient temperature is below 120° F (48° C) before using the system.
T3CM	MCM		MCM Temperature Cutback	Motor control temperature is too high.	Ensure ambient temperature is below 120°F(48°C). Verify that all fans are working.
T4CM	MCM		High Temperature MCM	High ambient temperature.	Ensure ambient temperature is below 120°F(48°C) before using the system.
				Enclosure fan not operating.	Ensure fan in electrical enclosure is spinning. If it is not, check fan wiring or replace fan.

Troubleshooting



Error	Location	Type	Description	Cause	Solution
T4CT	TCM		High Temperature TCM	High ambient temperature.	Ensure ambient temperature is below 120°F(48°C) before using the system.
				Enclosure fan not operating.	Ensure fan in electrical enclosure is spinning. If it is not, check fan wiring or replace fan.
				Module fan not operating.	If a TCM fan error (WMIO) has occurred, fan inside the module is not working properly. Check TCM fan for debris and clear with forced air if necessary.
T4DA	Heater A		High Temperature A	Bad RTD or bad RTD placement against heater.	Swap A and B heater output cables and RTD cables and see if issue follows. If so, replace RTD.
				Flow too high for temperature setpoint, causing temperature overshoots when gun is de-triggered.	Use a smaller mix chamber that is rated for the unit in use.
T4DB	Heater B		High Temperature B	Bad RTD or bad RTD placement against heater.	Swap A and B heater output cables and RTD cables and see if issue follows. If so, replace RTD.
				Flow too high for temperature setpoint, causing temperature overshoots when gun is de-triggered.	Use a smaller mix chamber that is rated for the unit in use.

Error	Location	Type	Description	Cause	Solution
T4DH	Hose		High Temperature Hose	Hose portion exposed to an excessive heat source, like hot sun or coiled hose, can pass fluid more than 27°F (15°C) over hose temperature setting to the FTS.	Shade exposed hose from hot sun or expose FTS to same environment when at rest. Uncoil entire hose before heating to avoid self-heating.
				Setting the A or B setpoint much higher than hose setpoint can cause fluid more than 27°F (15°C) over hose temperature setting to reach the FTS.	Increase hose setpoint so it is closer to A and B setpoints.
T4EA	Heater A		High Temperature Switch A	Overtemperature switch sensed a fluid temperature above 230°F (110°C).	Heater was delivered too much power, causing the overtemperature switch to open. RTD is not reading properly. After the heater cools down, replace RTD. Switch closes and the error can be cleared when the heater temperature falls below 190°F (87°C).
				Disconnected or loose overtemperature switch cable/connection.	If heater is not actually over temperature, check all wiring and connections between the TCM and the overtemperature switches.
				Overtemperature switch failed in the open position.	Replace overtemperature switch.

Error	Location	Type	Description	Cause	Solution
T4EB	Heater B		High Temperature Switch B	Overtemperature switch sensed a fluid temperature above 230°F (110°C).	Heater was delivered too much power, causing the overtemperature switch to open. RTD is not reading properly. After the heater cools down, replace RTD. Switch closes and the error can be cleared when the heater temperature falls below 190°F (87°C).
				Disconnected or loose overtemperature switch cable/connection.	If heater is not actually over temperature, check all wiring and connections between the TCM and the overtemperature switches.
				Overtemperature switch failed in the open position.	Replace overtemperature switch.
T4NM	MCM		High Temperature Motor	Cooling fan is not operating properly.	Check to see that the motor fan is moving. Measure voltage to fan. There should be 24 VDC. If no voltage is measured, check fan wiring. If the fan has voltage but is not moving, replace fan. If necessary use an air hose to blow out around the fan housings and remove any built-up debris.
				High ambient temperature.	Ensure ambient temperature is below 120°F(48°C) before using the system.
				Motor is operating outside of the pressure flow curve	Run the system at a lower duty cycle or with a smaller mix chamber.
				Motor temperature sensor wires are shorted together	Measure resistance between pins 2 and 4 on motor temperature cable connector at MCM, port 2. A reading below 75 ohms indicates a wire short. Replace motor.





Error	Location	Type	Description	Cause	Solution
T6DA	Heater A		Sensor Error A	Disconnected or loose RTD cable or connection.	Check all wiring and connection to RTD.
				Bad RTD.	Switch the RTD with another and see if the error message follows the RTD. Replace RTD if the error follows the RTD.







Troubleshooting

Error	Location	Type	Description	Cause	Solution
T6DB	Heater B		Sensor Error B	Disconnected or loose RTD cable or connection.	Check all wiring and connection to RTD.
				Bad RTD.	Switch the RTD with another and see if the error message follows the RTD. Replace RTD if the error follows the RTD.
T6DH	Hose		Sensor Error Hose	Disconnected or shorted RTD cable in hose or bad FTS.	Expose each hose RTD connection to check and retighten any loose connector. Measure hose RTD cable and FTS continuity. See Repair Heated Hose, page 66 . Order RTD Test kit 24N365 for measurement. Disconnect hose RTD and use manual hose mode to finish job until repair can be completed.
T6DT	TCM		Sensor Error TCM	Shorted RTD cable in hose or FTS.	Expose each hose RTD connection to check for exposed and shorted RTD wires. Measure hose RTD cable and FTS continuity. See Repair Heated Hose, page 66 . Order RTD Test kit 24N365 for measurement. Disconnect hose RTD and use manual hose mode to finish job until repair can be completed.
				Shorted A or B Heater RTD	If the error still occurs with the hose FTS unplugged, one of the heater RTDs is bad. Unplug the A or B RTD from the TCM. If unplugging an RTD fixes the T6DT error, replace the RTD.







Error	Location	Type	Description	Cause	Solution
T6NM	MCM		Sensor Error Motor	Disconnected or loose motor temperature cable connector	Verify proper cable connection at MCM, port 2. Measure resistance between pins 2 and 4 on motor temperature cable connector. A correct ohm reading will vary greatly with temperature. An open circuit reading indicates a wire break. Replace motor.





Troubleshooting

Error	Location	Type	Description	Cause	Solution
T8DA	Heater A		No Temperature Rise A	Bad RTD or bad RTD placement against heater.	Swap A and B heater output cables and RTD cables and see if issue follows. If so, replace RTD.
				Bad heater rod or loose heater wire.	Confirm resistance of heater. Heater resistance should be 9-12 Ω for 10 kW systems and 6-8 Ω for 15 kW systems. If out of tolerance, check for loose heater rod wire(s). Reconnect wires or replace heater rod if necessary.
				Started spraying before heater reached operating temperature.	Wait until operating temperature has been reached before spraying or recirculating.
T8DB	Heater B		No Temperature Rise B	Bad RTD or bad RTD placement against heater.	Swap A and B heater output cables and RTD cables and see if issue follows. If so, replace RTD.
				Bad heater rod or loose heater wire.	Confirm resistance of heater. Heater resistance should be 9-12 Ω for 10 kW systems and 6-8 Ω for 15 kW systems. If out of tolerance, check for loose heater rod wire(s). Reconnect wires or replace heater rod if necessary.
				Started spraying before heater reached operating temperature.	Wait until operating temperature has been reached before spraying or recirculating.
T8DH	Hose		No Temperature Rise Hose	Started spraying before heater reached operating temperature.	Wait until operating temperature has been reached before spraying or recirculating.
V1CM	MCM		Low Voltage MCM	Loose/bad connection or tripped circuit breaker.	Check wiring for loose connection or tripped circuit breaker.
				Low incoming line voltage.	Measure voltage at circuit breaker and ensure voltage is greater than 195 VAC.

Error	Location	Type	Description	Cause	Solution
V1IT	TCM		Low Voltage CAN	Bad 24 VDC power supply.	Check voltage of power supply. Voltage should be 23-25 VDC. If out of tolerance, replace power supply.
V2IT	TCM		Low Voltage CAN	Bad 24 VDC power supply.	Check voltage of power supply. Voltage should be 23-25 VDC. If out of tolerance, replace power supply.
V2MA	TCM		Low Voltage A	Loose connection or tripped circuit breaker.	Check wiring for loose connection or tripped circuit breaker.
				Low incoming line voltage.	Measure voltage at circuit breaker and ensure voltage is greater than 195 VAC.
V2MB	TCM		Low Voltage B	Loose connection or tripped circuit breaker.	Check wiring for loose connection or tripped circuit breaker.
				Low incoming line voltage.	Measure voltage at circuit breaker and ensure voltage is greater than 195 VAC.
V2MH	TCM		Low Voltage Hose	Loose connection or tripped circuit breaker.	Check wiring for loose connection or tripped circuit breaker.
				Low incoming line voltage.	Measure voltage at circuit breaker and ensure voltage is greater than 195 VAC.
V3IT	TCM		High Voltage CAN	Bad 24 VDC power supply.	Check voltage of power supply. Voltage should be 23-25 VDC. If out of tolerance, replace power supply.
V3MA	TCM		High Voltage A	Incoming line voltage is too high.	Ensure incoming system power is wired properly. Verify voltage at each circuit breaker is between 195 and 264 VAC.

Troubleshooting

Error	Location	Type	Description	Cause	Solution
V3MB	TCM		High Voltage B	Incoming line voltage is too high.	Ensure incoming system power is wired properly. Verify voltage at each circuit breaker is between 195 and 264 VAC.
V3MH	TCM		High Voltage Hose	Incoming line voltage is too high.	Ensure incoming system power is wired properly. Verify voltage at each circuit breaker is between 195 and 264 VAC.
V4CM	MCM		High Voltage MCM	Incoming line voltage is too high.	Ensure incoming system power is wired properly. Verify voltage at each circuit breaker is between 195 and 264 VAC.
V4IT	TCM		High Voltage CAN	Bad 24 VDC power supply.	Check voltage of power supply. Voltage should be 23-25 VDC. If out of tolerance, replace power supply.
V4MA	TCM		High Voltage A	Incoming line voltage is too high.	Ensure incoming system power is wired properly. Verify voltage at each circuit breaker is between 195 and 264 VAC.
V4MB	TCM		High Voltage B	Incoming line voltage is too high.	Ensure incoming system power is wired properly. Verify voltage at each circuit breaker is between 195 and 264 VAC.
V4MH	TCM		High Voltage Hose	Incoming line voltage is too high.	Ensure incoming system power is wired properly. Verify voltage at each circuit breaker is between 195 and 264 VAC.

Error	Location	Type	Description	Cause	Solution
WBC0	MCM		Software Version Error	Incorrect software version.	Insert a system token into the ADM module and cycle the power. Wait until the upload is complete before removing the token.
				MCM does not have line voltage.	If V1CM also exists, see troubleshooting for V1CM. The software version cannot be read if the MCM does not have line voltage.
WM10	TCM		TCM Fan Error	Fan inside TCM is not operating properly.	Check for debris in the TCM fan and clear with forced air if necessary.
WSUX	USB		Configuration Error USB	A valid configuration file can't be found for the USB.	Inset a system token into the ADM and cycle power. Wait until the lights on the USB port stop flashing before removing token.
WXUD	ADM		USB Download Error	Log download failed.	Backup and reformat the USB drive. Retry download.
WXUU	ADM		USB Upload Error	Custom language file failed to upload.	Perform normal USB download and use the new disptext.txt file to upload the custom language.

System



Before performing any troubleshooting procedures:

1. Relieve Pressure. See [Pressure Relief Procedure, page 46](#).
2. Turn main power switch OFF.
3. Allow equipment to cool.

Problem	Cause	Solution
Reactor ADM does not turn on.	No power.	Turn main power switch ON.
	Failed 24 V power supply.	Replace power supply.
	Failed surge protector.	Replace surge protector.
Electric motor does not operate.	Loose connections.	Check MCM connection 13.
	Tripped circuit breaker (CB02).	Reset breaker, see Repair Circuit Breaker Module, page 58 . Check 240VAC at output of breaker.
	Shorted windings.	Replace motor, see Repair Electric Motor, page 57 .
Electric motor runs erratically.	Failed motor bearing.	Replace motor, see Repair Electric Motor, page 57 .

Problem	Cause	Solution
Cooling fans not working.	Loose wire.	Check. See Electrical Schematics, page 93.
	Fan blade obstructed.	Remove obstruction.
	Defective fan.	Replace. See Replace Motor Fan, page 60.
Pump output low.	Obstructed fluid hose or gun; fluid hose ID too small.	Open, clear; use hose with larger ID.
	Worn piston valve or intake valve in displacement pump.	See pump manual.
	Pressure setpoint too high.	Reduce setpoint and output will increase.
Fluid leak in pump packing nut area.	Worn throat seals.	Replace. See pump manual.
No pressure on one side.	Fluid leaking from heater inlet rupture disk (372).	Check if heater and PRESSURE RELIEF/SPRAY valve (SA or SB) are plugged. Clear. Replace rupture disk (372) with a new one; do not replace with a pipe plug.

Hose Heat System

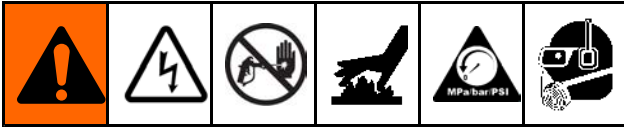

Before performing any troubleshooting procedures:

1. Relieve Pressure. See [Pressure Relief Procedure, page 46](#).
2. Turn main power switch OFF.
3. Allow equipment to cool.

Problem	Cause	Solution
Hose heats but heats slower than usual or it does not reach temperature.	Ambient temperature is too cold.	Relocate hoses to a warmer area or recirculate heated fluid through the hose.
	FTS failed or not installed correctly.	Check FTS, see Check RTD Cables and FTS, page 67 .
	Low supply voltage.	Verify line voltage. Low line voltage significantly reduces power available to the hose heat system, affecting longer hose lengths.
Hose does not maintain temperature while spraying.	A and B setpoints too low.	Increase A and B setpoints. Hose is designed to maintain temperature, not to increase it.
	Ambient temperature is too cold.	Increase A and B setpoints to increase fluid temperature and keep it steady.
	Flow too high.	Use smaller mix chamber. Decrease pressure.
	Hose was not fully preheated.	Wait for hose to heat to correct temperature before spraying.
	Low supply voltage.	Verify line voltage. Low line voltage significantly reduces power available to the hose heat system, affecting longer hose lengths.

Problem	Cause	Solution
Hose temperature exceeds setpoint.	A and/or B heaters are overheating material.	Check primary heaters for either a RTD problem or a failed element attached to RTD, see Electrical Schematics, page 93 .
	Faulty FTS connections.	Verify that all FTS connections are snug and that pins of connectors are clean. Unplug and re-plug RTD wires, cleaning off any debris.
	Ambient temperature is too high.	Cover hoses or move to a location with a lower ambient temperature.
	Missing or damaged insulation around FTS, causing the hose heat to be ON constantly.	Make sure the hose bundle has adequate insulation evenly covering the entire length and connection joints.

Troubleshooting

Problem	Cause	Solution
Erratic hose temperature.	Faulty FTS connections.	Verify that all FTS connections are snug and that pins of connectors are clean. Unplug and re-plug FTS wires along length of hose, cleaning off any debris.
	FTS not installed correctly.	FTS should be installed close to end of hose in same environment as gun. Verify FTS installation, see Repair Fluid Temperature Sensor (FTS), page 68 .
	Missing or damaged insulation around FTS, causing the hose heat to be ON constantly.	Make sure the hose bundle has adequate insulation evenly covering the entire length and connection joints.
Hose does not heat.	FTS failed.	Check FTS, see Repair Fluid Temperature Sensor (FTS), page 68 .
	FTS not installed correctly.	FTS should be installed close to end of hose in same environment as gun. Verify FTS installation, see Repair Fluid Temperature Sensor (FTS), page 68 .
	Loose hose electrical connections.	Check connections. Repair as necessary.
	Circuit breakers tripped.	Reset breakers (CB01), see Repair Circuit Breaker Module, page 58 .
	Hose zone not turned on.	Turn on hose heat zone.
	A and B temperature setpoints too low.	Check. Increase if necessary.

Problem	Cause	Solution
Hoses near Reactor are warm, but hoses downstream are cold.	Shorted connection or failed hose heating element.	With power off, check the hose resistance with and without the whip hose attached. With the whip hose attached, the reading should be less than 3 ohm. Without the whip hose attached, the reading should be OL (open loop). See Check Hose Heat Power Connectors, page 66 .
Low hose heat.	A and B temperature setpoints too low.	Increase A and B setpoints. Hose designed to maintain temperature, not increase temperature.
	Hose temperature setpoint too low.	Check. Increase if necessary to maintain heat.
	Flow too high.	Use smaller mix chamber. Decrease pressure.
	Low current; FTS not installed.	Install FTS, see operation manual.
	Hose heat zone not turned on long enough to reach setpoint.	Allow hose to heat up, or preheat fluid.
	Loose hose electrical connections.	Check connections. Repair as necessary.
	Ambient temperature is too low	Relocate hoses to a warmer area or increase A and B setpoints.

Primary Heater

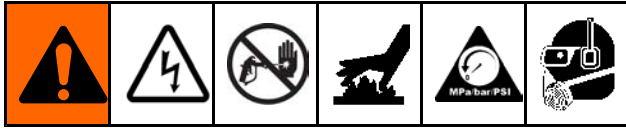

Before performing any troubleshooting procedures:

1. Relieve Pressure. See [Pressure Relief Procedure, page 46](#).
2. Turn main power switch OFF.
3. Allow equipment to cool.

Problems

Try the recommended solutions in the order given for each problem, to avoid unnecessary repairs. Also, determine that all circuit breakers, switches, and controls are properly set and wiring is correct before assuming there is a problem.

Problem	Cause	Solution
Primary Heater(s) does not heat.	Heat turned off.	Turn on heat zones.
	Temperature control alarm.	Check ADM for error codes.
	Signal failure from RTD.	Signal failure from RTD.
Control of primary heat is abnormal; high temperature overshoots (T4DA, T4DB) occurs intermittently.	Dirty RTD connections.	Examine RTD cables connected to TCMs. Confirm RTDs are not plugged into opposite heat zone. Unplug and re-plug RTD connectors. Unplug and re-plug RTD connectors. Ensure RTD tip contacts the heater element.
	RTD not contacting heater element.	Loosen ferrule nut, push in RTD so tip contacts heater element. Holding RTD tip against heater element, tighten ferrule nut 1/4 turn past tight.
	Failed heater element.	See Replace Heater Element, page 62 .
	Signal failure from RTD.	See (T6DA, T6DB), Error Codes .

Graco InSite

Problem	Cause	Solution
No module status LEDs are illuminated.	No power to cellular module.	Turn Reactor ON.
		Ensure unit is properly installed.
		Verify 24V at output of the power supply.
		Make sure the M8, 4-pin to M12, 8-pin cable is installed between cellular module and power supply.
Has not identified GPS location (green module status LED flashing).	Still identifying location.	Wait a few minutes for the unit to identify the location.
	Unable to identify location. In a location where GPS lock cannot occur. Buildings and warehouses often prevent GPS locks.	Move system to a location with a clear view of the sky.
		Use extension cable 16X521 and move cellular module to a location with a clear view of the sky.
Has not established cellular connection (orange module status LED flashing).	Still establishing cellular connection.	Wait a few minutes for the unit to establish the connection.
	Unable to establish cellular connection.	Move system to a location with cellular service to establish cellular connection.
		Use extension cable 16X521 and move cellular module to a location with a clear view of the sky.
Cannot view data for my unit(s) on website.	Graco InSite unit has not been activated.	Activate unit. See Registering and Activating the Graco InSite section.
Temperature data not displayed on website.	Reactor temperature measurement is not working.	See System troubleshooting section.
Hose zone temperature data not displayed on website.	The RTD or thermocouple is not correctly installed on the hose or is broken.	See RTD or Thermocouple repair section.
Pressure data not displayed on website.	Reactor pressure measurement is not working.	See System troubleshooting section.

Pressure Relief Procedure



Follow the Pressure Relief Procedure whenever you see this symbol.

<p>This equipment stays pressurized until pressure is manually relieved. To help prevent serious injury from pressurized fluid, such as skin injection, splashing fluid and moving parts, follow the Pressure Relief Procedure when you stop spraying and before cleaning, checking, or servicing equipment.</p>					

The Fusion AP gun is shown.

1. Relieve pressure in gun and perform gun shutdown procedure. See gun manual.
2. Close gun fluid inlet valves A and B.

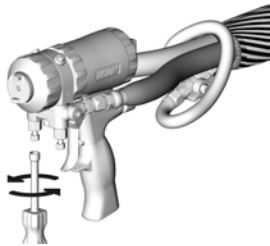

3. Shut off feed pumps and agitator, if used.

4. Route fluid to waste containers or supply tanks. Turn PRESSURE RELIEF/SPRAY valves (SA, SB) to PRESSURE RELIEF/CIRCULATION



Ensure gauges drop to 0.

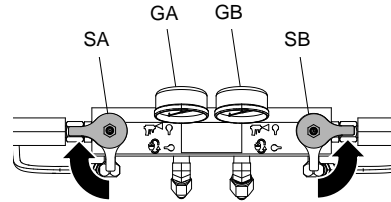

5. Engage gun piston safety lock.



6. Disconnect gun air line and remove gun fluid manifold.

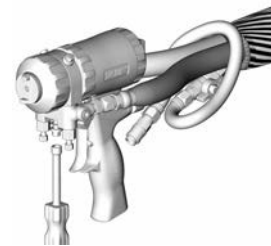

Shutdown



Shutdown system to avoid electric shock. All electrical wiring must be done by a qualified electrician and comply with all local codes and regulations. To help prevent serious injury from pressurized fluid, such as skin injection, splashing fluid and moving parts, follow the Pressure Relief Procedure when you stop spraying and before cleaning, checking, or servicing equipment.

NOTICE

Proper system setup, startup, and shutdown procedures are critical to electrical equipment reliability. The following procedures ensure steady voltage. Failure to follow these procedures will cause voltage fluctuations that can damage electrical equipment and void the warranty.

1. Press  to stop the pumps.



2. Turn off all heat zones.

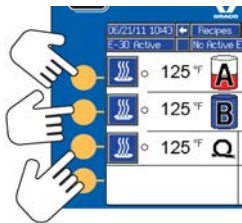

3. Relieve pressure. See [Pressure Relief Procedure, page 46](#).

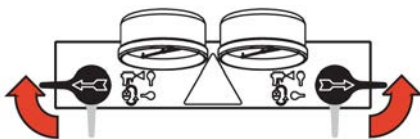

4. Press  to park the Component A Pump. The park operation is complete when green dot goes out. Verify the park operation is complete before moving to next step.

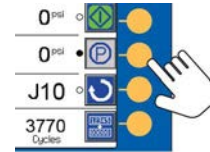

5. Press  to deactivate the system.





6. Turn off the air compressor, air dryer, and breathing air.

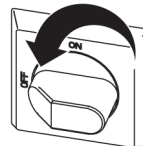

7. Turn main power switch OFF.



			
To prevent electric shock do not remove any shrouds or open the electrical enclosure door.			

Shutdown

8. Close all fluid supply valves.

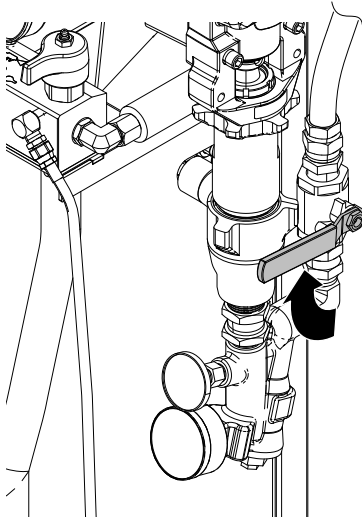

9. Engage gun piston safety lock then close fluid inlet valves A and B.

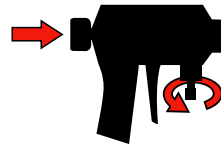

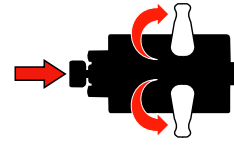

Fusion



Probler

Flushing

					
<p>To avoid fire and explosion:</p> <ul style="list-style-type: none"> • Flush equipment only in a well-ventilated area. • Do not turn on heaters until fluid lines are clear of solvent. • Flush out old fluid with new fluid, or flush out old fluid with a compatible solvent before introducing new fluid. • Use the lowest possible pressure when flushing. • All wetted parts are compatible with common solvents. Use only moisture-free solvents. 					

To flush feed hoses, pumps, and heaters separately from heated hoses, set PRESSURE RELIEF/SPRAY valves (SA, SB) to PRESSURE

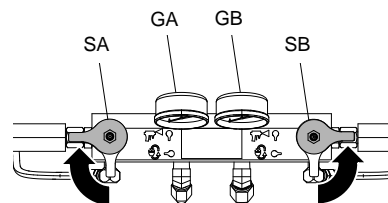

RELIEF/CIRCULATION . Flush through bleed lines (N).



To flush entire system, circulate through gun fluid manifold (with manifold removed from gun).

To prevent moisture from reacting with isocyanate, always leave the system filled with a moisture-free plasticizer or oil. Do not use water. Never leave the system dry. See [Important Isocyanate Information](#).

Repair

					
<p>Repairing this equipment requires access to parts that may cause electric shock or other serious injury if work is not performed properly. Be sure to shut off all power to equipment before repairing.</p>					

Before Beginning Repair

NOTICE
<p>Proper system setup, startup, and shutdown procedures are critical to electrical equipment reliability. The following procedures ensure steady voltage. Failure to follow these procedures will cause voltage fluctuations that can damage electrical equipment and void the warranty.</p>

1. Flush if necessary. See [Flushing, page 49](#).
2. See [Shutdown, page 47](#).

Flush Inlet Strainer Screen

					
---	---	---	--	--	--

The inlet strainers filter out particles that can plug the pump inlet check valves. Inspect the screens daily as part of the startup routine, and clean as required.

Isocyanate can crystallize from moisture contamination or from freezing. If the chemicals used are clean and proper storage, transfer, and operating procedures are followed, there should be minimal contamination of the A-side screen.

Note

Clean the A-side screen only during daily startup. This minimizes moisture contamination by immediately flushing out any isocyanate residue at the start of dispensing operations.

1. Close the fluid inlet valve on the y-strainer inlet and shut off the appropriate feed pump. This prevents material from being pumped while cleaning the screen.
2. Place a container under the strainer base to catch drain off when removing the strainer plug (C).
3. Remove the screen (A) from the strainer manifold. Thoroughly flush the screen with compatible solvent and shake it dry. Inspect the screen. No more than 25% of the mesh should be restricted. If more than 25% of the mesh is blocked, replace the screen. Inspect the o—ring (B) and replace as required.
4. Ensure the pipe plug (D) is screwed into the strainer plug (C). Install the strainer plug with the screen (A) and o—ring (B) in place and tighten. Do not overtighten. Let the gasket make the seal.
5. Open the fluid inlet valve, ensure that there are no leaks, and wipe the equipment clean. Proceed with operation.

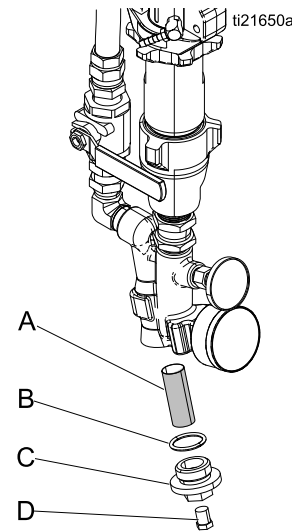

Figure 1

Change Pump Lubricant

Check the condition of the ISO pump lubricant daily. Change the lubricant if it becomes a gel, its color darkens, or it becomes diluted with isocyanate.

Gel formation is due to moisture absorption by the pump lubricant. The interval between changes depends on the environment in which the equipment is operating. The pump lubrication system minimizes exposure to moisture, but some contamination is still possible.

Lubricant discoloration is due to continual seepage of small amounts of isocyanate past the pump packings during operation. If the packings are operating properly, lubricant replacement due to discoloration should not be necessary more often than every 3 or 4 weeks.

To change pump lubricant:

1. Follow [Pressure Relief Procedure, page 46](#).
2. Lift the lubricant reservoir (R) out of the bracket and remove the container from the cap. Holding the cap over a suitable container, remove the check valve and allow the lubricant to drain. Reattach the check valve to the inlet hose.
3. Drain the reservoir and flush it with clean lubricant.
4. When the reservoir is flushed clean, fill with fresh lubricant.

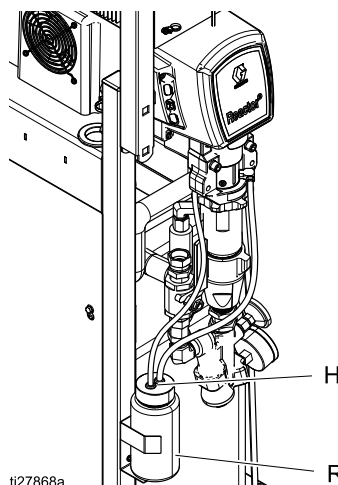

5. Thread the reservoir onto the cap assembly and place it in the bracket.
6. Manually prime the ISO pump. Plug the small vent hole (H) between the tube grommets while squeezing the bottle to force the lubricant up the feed tube. Repeat until the fluid level reaches the ISO pump to force the air out.



Pump Lubrication System
Figure 2



7. Verify that the ISO pump is operating correctly by feeling the pulsation in the return tube during normal proportioner pump operation.
8. Ensure the vent hole stays open.

Remove Pump

					
<p>Pump rod and connecting rod move during operation. Moving parts can cause serious injury such as pinching or amputation. Keep hands and fingers away from connecting rod during operation.</p>					

Note

See manual 309577 for pump repair instructions.

1. Press  to stop the pumps.
2. Turn off heat zones.
3. Flush pump.
4. Press  to park the pumps in the down position.
5. Press  to deactivate the system.
6. Turn main power switch off.



7. Shut off both feed pumps. Close all fluid supply valves.

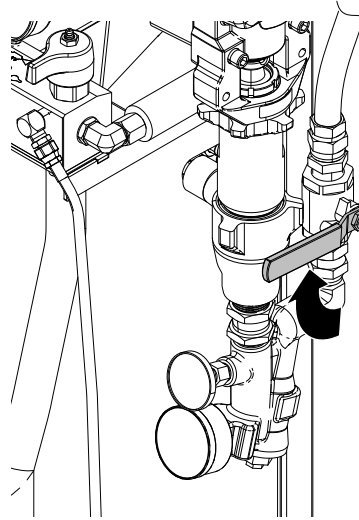

8. Route fluid to waste containers or supply tanks. Turn PRESSURE RELIEF/SPRAY valves (SA, SB) to PRESSURE RELIEF/CIRCULATION . Ensure gauges drop to 0.

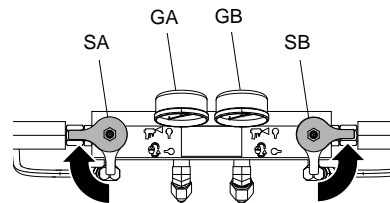

Note

Use drop cloth or rags to protect Reactor and surrounding areas from spills.

Note

Steps 9–11 apply to pump A. To disconnect pump B, go to steps 12 and 13.

9. Disconnect fittings at fluid inlet (C) and outlet (D). Also disconnect steel outlet tube from heater inlet.
10. Disconnect tubes (T). Remove both tube fittings (U) from wet-cup.
11. Loosen locknut (G) by hitting firmly with a non-sparking hammer. Unscrew pump far enough to expose rod retaining pin. Push retaining wire clip up. Push pin out. Continue unscrewing pump.

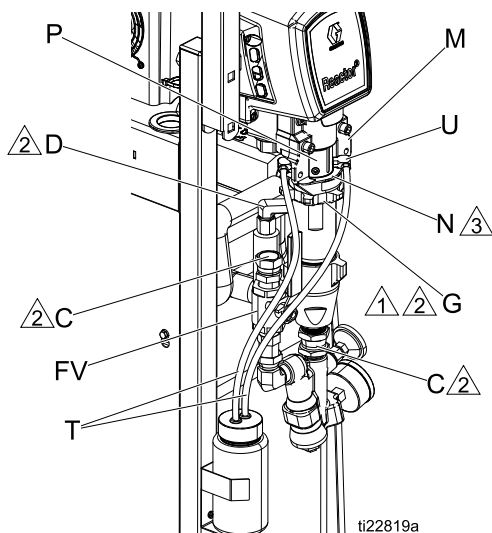

Pump A
Figure 3

- 1 Flat side faces up.
- 2 Lubricate threads with ISO oil or grease.
- 3 Pump top threads must be nearly flush with bearing face (N).

Note

Steps 12 and 13 apply to pump B.

12. Disconnect fluid inlet (C) and outlet (D). Also disconnect steel outlet tube from heater inlet.
13. Push retaining wire clip (E) up. Push pin (F) out. Loosen locknut (G) by hitting firmly with a non-sparking hammer. Unscrew pump.

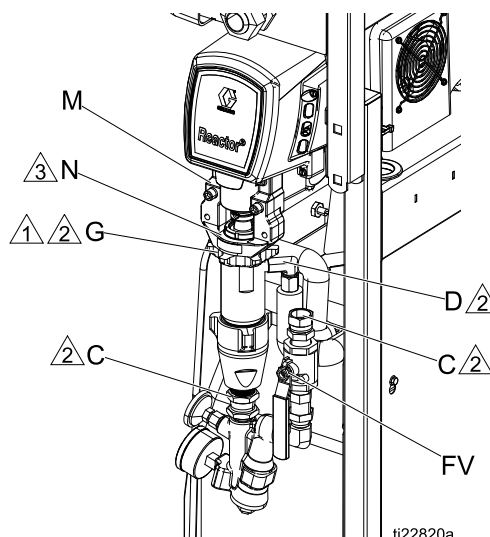

Pump B
Figure 4

- 1 Flat side faces up.
- 2 Lubricate threads with ISO oil or grease.
- 3 Pump top threads must be nearly flush with bearing face (N).

Install Pump

Note

Steps 1–5 apply to pump B. To reconnect pump A, proceed to step 6.

1. Ensure locknut (G) is screwed on pump with flat side up. Screw pump into bearing housing (M) until pin holes align. Push pin (F) in. Pull retaining wire clip (E) down. See Fig. 4 for view and assembly notes.
2. Continue screwing pump into housing until fluid outlet (D) is aligned with steel tube and top threads are +/- 1/16 in. (2 mm) of bearing face (N).
3. Tighten locknut (G) by hitting firmly with a non-sparking hammer.
4. Reconnect fluid inlet (C) and outlet (D).
5. Go to step 13.

Note

Steps 6–12 apply to pump A only.

6. Ensure star-shaped locknut (G) is screwed on pump with flat side up. Carefully twist and extend displacement rod 2 in. (51 mm) above wet-cup.

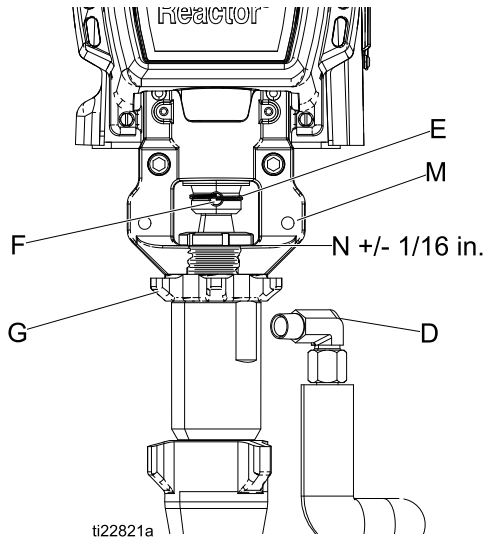

Figure 5

7. Start threading pump into bearing housing (M). When pin holes align, insert pin. Pull retaining wire clip down.
8. Continue threading pump into bearing housing (M) until top threads are +/- 1/16 in. (2 mm) of bearing face (N). Ensure that barbed fittings at wet-cup flush ports are accessible.
9. Connect component A outlet tube loosely at pump and at heater. Line up tube, then tighten fittings securely.
10. Tighten star-shaped locknut (G) by hitting firmly with a non-sparking hammer.

11. Apply thin film of TSL to barbed fittings. Using two hands, support tubes (T) while pushing straight onto barbed fittings. Secure each tube with a wire tie between two barbs.



Note

Do not let tubes kink or buckle.

12. Reconnect fluid inlet (C).
13. Purge air and prime the system. See Reactor operation manual.

Repair Drive Housing

Removal

1. Press  to stop the pumps.
2. Turn off heat zones.
3. Flush pump.
4. Press  to park the pumps in the down position.
5. Press  to deactivate the system.
6. Turn main power switch off.

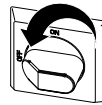

7. Perform [Pressure Relief Procedure](#), page 46.
8. Remove the system frame from the floor and L-brackets.

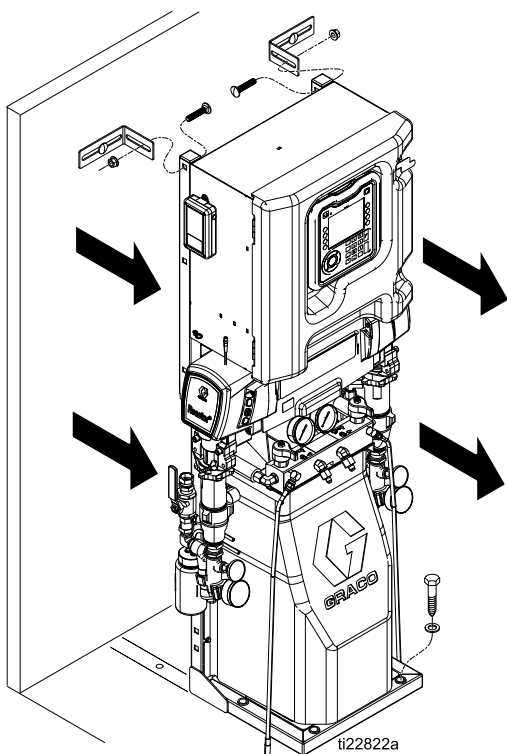

9. Remove two bolts and nuts and fold the electrical enclosure backward.
10. Remove screws (21) and motor shroud (11). Rest the motor shroud behind the motor without straining the fan power cable.

Note

Examine bearing housing (103) and connecting rod (105). If these parts need replacing, first remove the pump (106), see [Remove Pump](#), page 52.

11. Remove cover (60) and screws (21).
12. Remove cycle counter (121) from housing by removing screw (122).
13. Disconnect pump inlet and outlet lines. Remove screws (113), washers (115), and bearing housing (103).

NOTICE

Do not drop gear cluster (104) when removing drive housing (102). Gear cluster may stay engaged in motor front end bell or drive housing.

14. Remove screws (112, 119) and washers (114) and pull drive housing (102) off motor (101).

Note

The A side drive housing includes cycle counter switch (121). If replacing this housing, remove screws (122) and switch. Reinstall screws and switch on new drive housing.

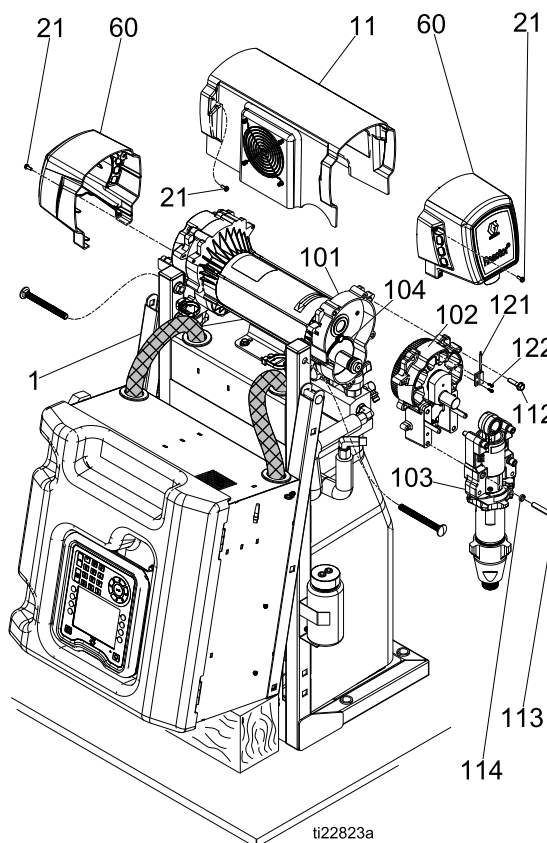

Figure 6

Installation

1. Apply heavy duty extreme pressure grease liberally to washers (107, 108, 118), all gears, and inside drive housing (102).
2. Install one bronze washer (108) in drive housing, then install steel washers (107, 118) as shown.
3. Install second bronze washer (108) on gear cluster (104) and insert gear cluster in drive housing.

Note

Drive housing crankshaft must be in line with crankshaft at other end of motor.

4. Push drive housing (102) onto motor (101). Install screws (112) and washers (114).

Note

If bearing housing (103), connecting rod (105), or pump (106) were removed, reassemble rod in housing and install pump, see [Install Pump, page 53](#).

5. Route cycle counter switch cable (121) around the motor fan and reattach to housing (102) with screws (122).
6. Install bearing housing (103), screws (113), and washers (114). Pumps must be in phase (both at same position in stroke).
7. Install cover (60) and screws (21).
8. Install motor shield (11) and screws (21).

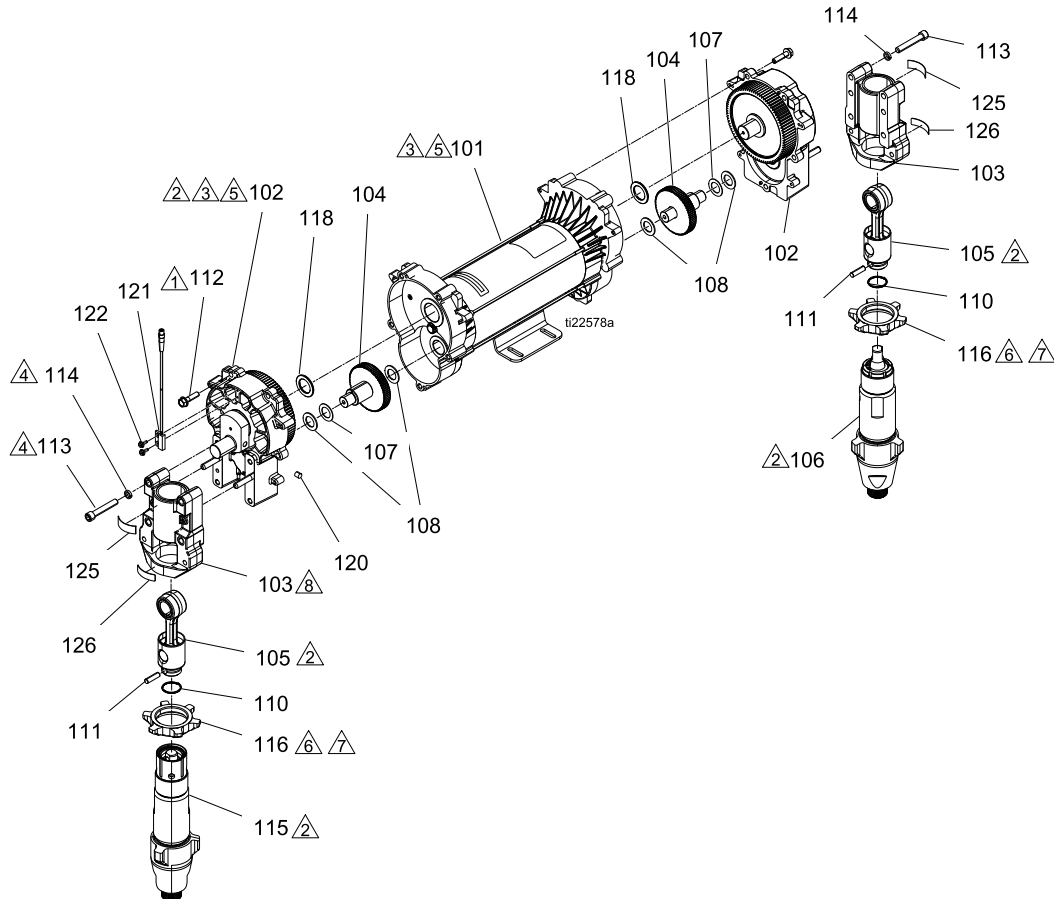

Figure 7

Repair Electric Motor

Removal

NOTICE

Be careful not to drop or damage the motor. The motor is heavy and may require two people to lift.

1. Remove the system frame from the floor and L-brackets.

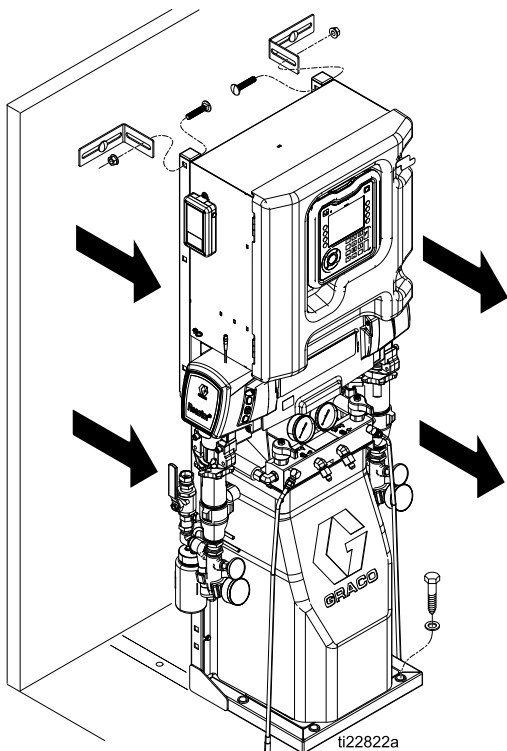

2. Remove drive housing and pump assemblies. See [Repair Drive Housing, page 54](#).
3. Disconnect electric motor (101) power cable from port #15 on the MCM. Remove connector by loosening four terminal screws.
4. Remove motor shroud (11). Rest the motor shroud assembly behind the motor without straining the fan power cable.
5. Disconnect over temperature cable from port #2 on MCM. Cut tie wraps around harness to remove cable.
6. Remove four screws (25) holding motor (101) to bracket. Lift motor off unit.

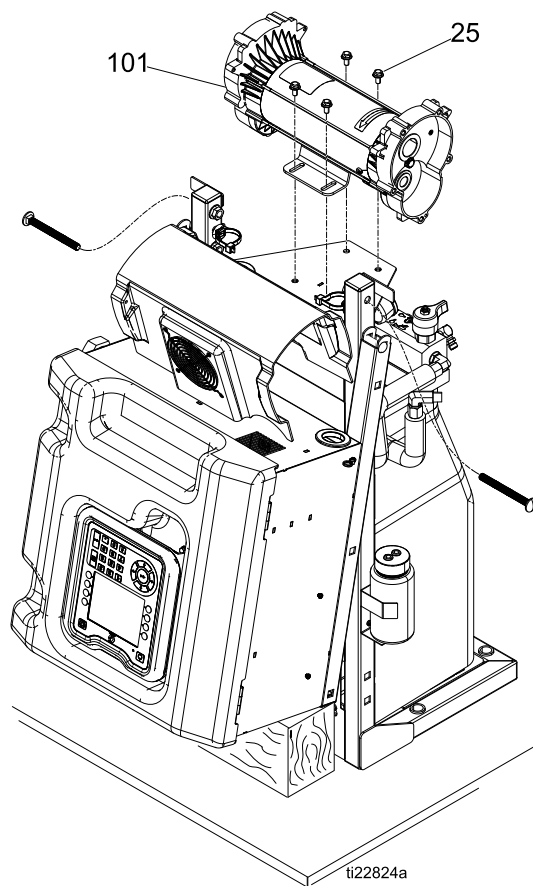

Installation

1. Place motor on unit. Thread motor cables into conduit as before. See [Electrical Schematics, page 93](#).
2. Fasten motor with screws (25) until screws are fully threaded in frame. Do not tighten screws until drive housing and pumps are connected to the motor.
3. Install drive housing and pump assemblies, see [Installation, page 56](#).
4. Route motor (101) power cord from motor through conduit and connect to port #15 on MCM. Route over temperature cable up from motor and connect to port #2 on MCM. Insert cables in conduit and use tie wraps to secure the conduit together.
5. Connect motor shroud assembly to motor (101).
6. Install drive housing covers and motor cover.
7. Return to service.

Repair Circuit Breaker Module

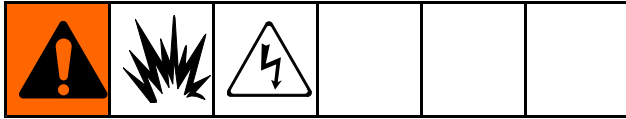

1. See [Before Beginning Repair, page 50](#).
2. Using an ohmmeter, check for continuity across circuit breaker (top to bottom). If no continuity, trip breaker, reset, and retest. If still no continuity, replace breaker as follows:
 - a. Refer to [Electrical Schematics, page 93](#), and circuit breaker table.
 - b. Follow Shutdown instructions. See [Shutdown, page 47](#).
 - c. Refer to circuit breaker identification table and electrical diagrams in Reactor repair manual.
 - d. Loosen two screws connecting wires and bus bar to circuit breaker that will be replaced. Disconnect wires.
 - e. Pull locking tab out 1/4 in. (6mm) and pull circuit breaker away from the din rail. Install

new circuit breaker. Insert wires and tighten down all screws.

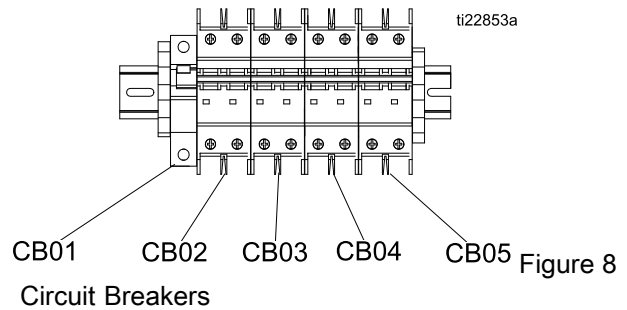

Circuit Breakers		
Ref.	Size	Component
CB01	50 A	Heated Hose
CB02	20 A	Motor Control Module (MCM)
CB03	40 A	ISO Heater
CB04	40 A	RES Heater
CB05	40 A	Hose Heat Transformer

Replace Fluid Inlet Sensor

Note

For Elite models only.

1. Perform [Shutdown](#), page 47.
2. Perform [Pressure Relief Procedure](#), page 46.
3. Disconnect inlet sensor cable from the fluid inlet assembly. Inspect cable for damage and replace if necessary. See [Electrical Schematics](#), page 93.

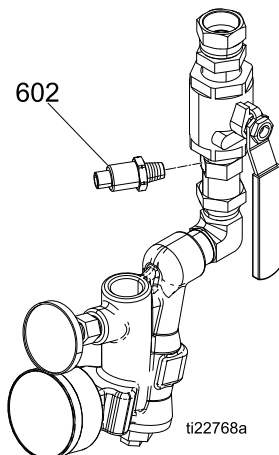

Figure 9 Fluid Inlet Sensor

4. To replace sensor cable:
 - a. Open wire bundle and remove sensor cable.
 - b. Cut any wire ties and disconnect from MCM. See [Electrical Schematics](#), page 93.

NOTICE

To prevent damage to cable, route and secure cable in wire bundle with wire ties.

5. Replace sensor (602).

Replace Pressure Transducers

1. Perform [Shutdown](#), page 47.
2. Perform [Pressure Relief Procedure](#), page 46.
3. Disconnect transducer cables (405) from #6 and #7 connectors on the MCM.
4. Remove wire ties constraining transducer cable and remove cable from cabinet.
5. Install o-ring (416) on new transducer (405).
6. Install transducer in manifold. Mark end of cable with tape (red=transducer A, blue=transducer B).
7. Route new cable into cabinet and thread into bundle as before. Attach cable ties to bundle as before.
8. Connect A side pressure transducer cable to MCM port #6. Connect B side pressure transducer cable to MCM port #7.

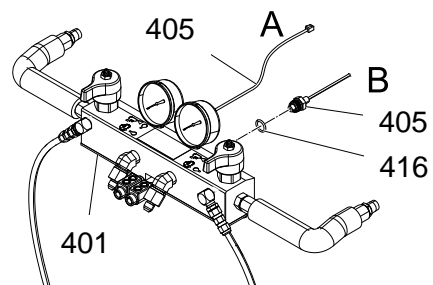

Replace Fans

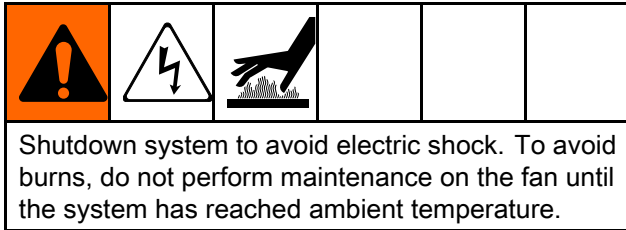

Replace Motor Fan

1. Perform [Shutdown](#), page 47.
2. Open cabinet door and disconnect fan cables from terminal blocks. See [Electrical Schematics](#), page 93.
3. Remove four screws (21) from motor cover (11). If necessary, fold frame (1) to remove motor cover (10). See [Repair Drive Housing](#), page 54, steps 1–10.
4. Cut tie wraps to remove cable.
5. Remove nuts (39), screws (22), washers (34) and fan (32). Install new fan in reverse order.

Note

Ensure fan (32) blows onto motor.

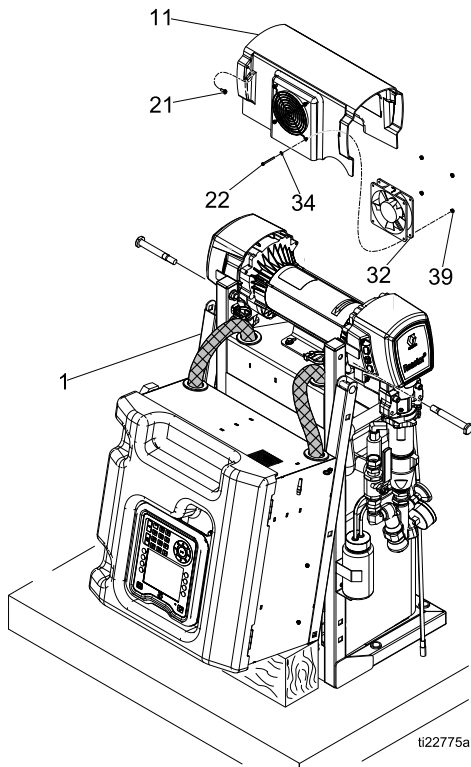

Figure 10

Replace Electrical Enclosure Fan

1. Perform [Shutdown](#), page 47
2. Open electrical enclosure door (401). Loosen four nuts (421) and remove fan (404).
3. Install new fan (404) in reverse order of disassembly so that the fan blows out of the electrical enclosure.

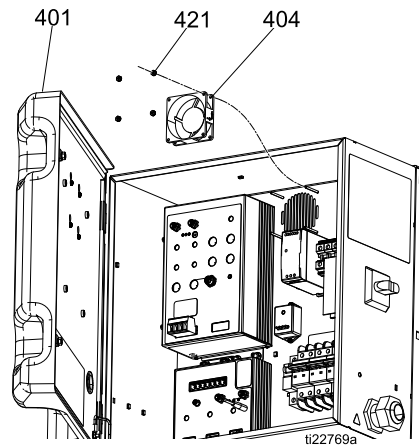
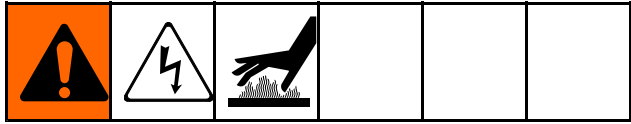

Figure 11

Replace Transformer Fan



1. Perform [Shutdown](#), page 47.
2. Remove four bolts (23) and shroud (10).
3. Remove bolt (20) on top of the heater junction box (48).
4. Disconnect fan and transformer connections from terminal blocks. Connections are on left side labeled: V+, V-, 1, 2, 3, and 4.
5. Remove four nuts (27) holding metal transformer cover (8) to frame. Carefully remove cover while sliding wires through hole in cover.
6. Remove four screws (23), washers (29), and fan (32).
7. Install fan in reverse order.

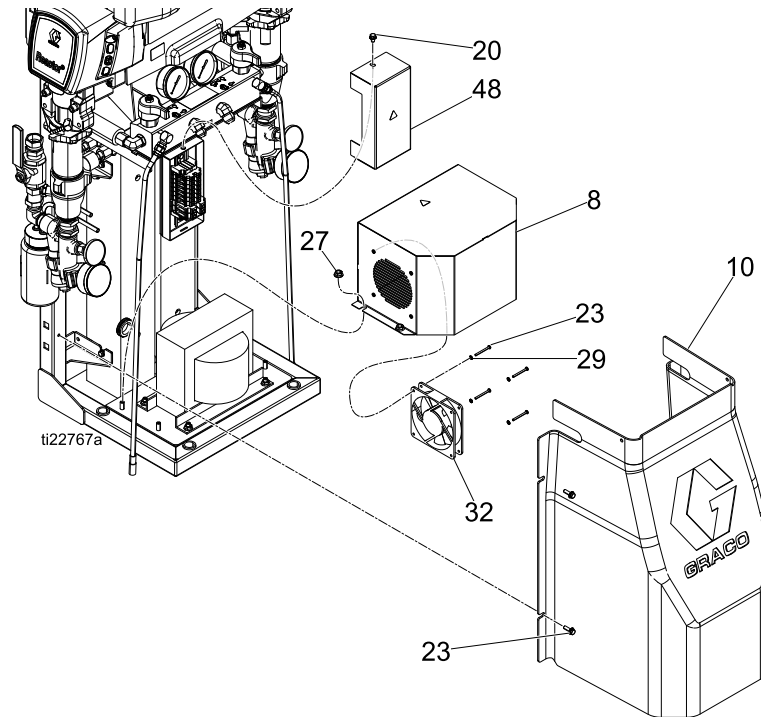
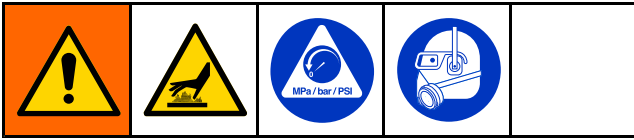
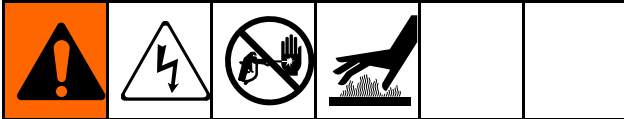

Figure 12

Repair Primary Heater



Replace Heater Element



1. Press  to stop the pumps.
2. Turn off heat zones.

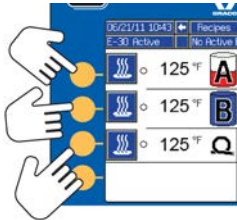

3. Flush pump.
4. Press  to park the pumps in the down position. The park operation is complete when green dot goes out. Verify the park operation is complete before moving to next step.

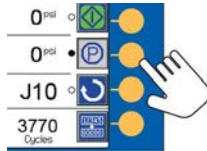

5. Press  to deactivate the system.



6. Turn main power switch off.



7. Relieve pressure. See [Pressure Relief Procedure, page 46](#).

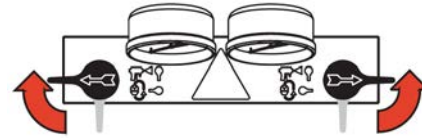

8. Wait for heater to cool.
9. Remove four bolts (23) and shroud (10).

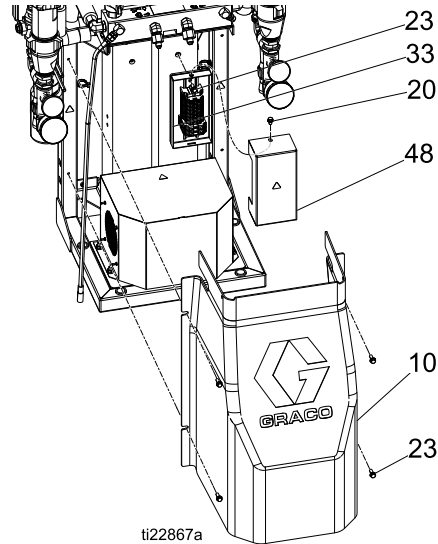

10. Remove screw (20) and lower din rail cover (48).
11. Disconnect heater wires:
 - a. A Side: Disconnect A side heater wires, transformer, and transformer fan wires from lower din rail (33).
 - b. B Side: Disconnect B side heater wires and remove lower din rail (33) from B side heater (5).
12. Test heater wires with ohmmeter.

System	Total Heater Wattage	Element	Ohms
E-30 (10 kw)	10,200	2,550	18–21 per element
E-XP2, E-30 (15 kw)	15,300	2,550	18–21 per element

NOTICE

To prevent a short circuit or lowering the transformer life, do not splash fluid on transformer. Cover transformer with a plastic sheet or piece of cardboard.

13. Remove nuts (27) and transformer cover (8). Cover transformer with plastic sheet or cardboard.
14. Disconnect overtemperature switches (209) from cable.
15. Loosen ferrule nut (N). Remove RTD (212) from heater housing. Do not remove adapter (206) unless necessary. If adapter must be removed, ensure that mixer (210) is out of the way when replacing adapter.
16. Disconnect inlet and outlet fluid tubes from heater.
17. Remove two bolts (23) and lift heater over transformer.
18. Place heater block (201) in a vise. Use a wrench to remove heater element (208).
19. Inspect element. It should be relatively smooth and shiny. Replace element if there is a crusted, burnt, ash-like material adhered to element, or sheath shows pitting marks.
20. Install new heater element (208), holding mixer (210) so it does not block RTD port.
21. Secure heater to frame with bolts (23).
22. Reinstall RTD (212), [Repair Primary Heater, page 62](#).
23. Reconnect cable to overtemperature switches (209).
24. Reconnect wires to lower din rail. If necessary, install lower din rail (33).
25. Install lower din rail cover (48).

Line Voltage

The heater outputs its rated wattage at 240 VAC. Low line voltage will reduce power available and the heater will not perform at full capacity.

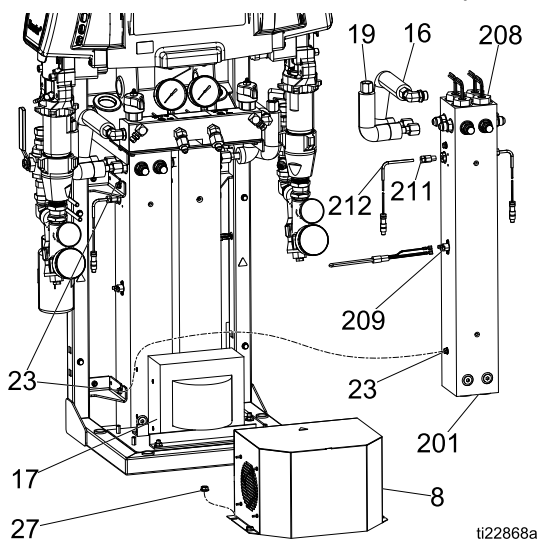
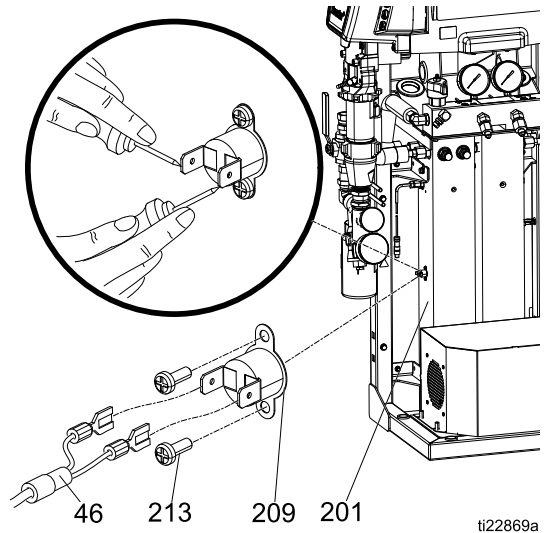

Figure 13

Repair Overtemperature Switch

1. Perform [Shutdown](#), page 47.
2. Wait for heaters to cool.
3. Remove heater cover (10).
4. Disconnect overtemperature switches (209) from cable (46). Test across spade terminals with ohmmeter.
 - a. If the resistance **is not** approximately 0 ohms, the overtemperature switch needs to be replaced. Go to step 5.
 - b. If the resistance **is** approximately 0 ohms, inspect cable (46) to ensure it is not cut or open. Reconnect the overtemperature switch (209) and cable (46). Disconnect cable from TCM. Test from pin 1 to 3 and 1 to 4. If resistance is not approximately 0, and switches are 0. Replace cable in place of original cable.
5. If switch fails test, remove screws. Discard failed switch. Apply a thin layer of thermal compound

110009, install new switch in same location on housing (201), and secure with screws (213). Reconnect cables.



Replace RTD

1. Perform [Shutdown, page 47](#).
2. Wait for heater to cool.
3. Remove heater cover (10).
4. Cut cable ties around the woven wrap with the RTD cable (212).
5. Disconnect RTD cable(212) from TCM (453).
6. Loosen ferrule nut (N). Remove RTD (212) from heater housing (201), then remove RTD housing (H). Do not remove the adapter (206) unless necessary. If adapter must be removed, ensure that mixer (210) is out of the way when replacing the adapter.
7. Remove RTD cable (212) from woven wrap.
8. Replace RTD (212).
 - a. Apply PTFE tape and thread sealant to male pipe threads and tighten RTD housing (H) into adapter (206).
 - b. Push in RTD (212) so tip contacts heater element (208).
 - c. Holding RTD (212) against heater element, tighten ferrule nut (N) 3/4 turn past finger-tight.
9. Route wires (S) as before through woven wrap and reconnect RTD cable (212) to the TCM.
10. Replace heater shroud (10).
11. Follow startup instructions in the operation manual. Turn on A and B heat simultaneously to test. Temperatures should rise at same rate. If one is low, loosen ferrule nut (N) and tighten RTD housing (H) to ensure RTD tip contacts element (212) when ferrule nut (N) is retightened.

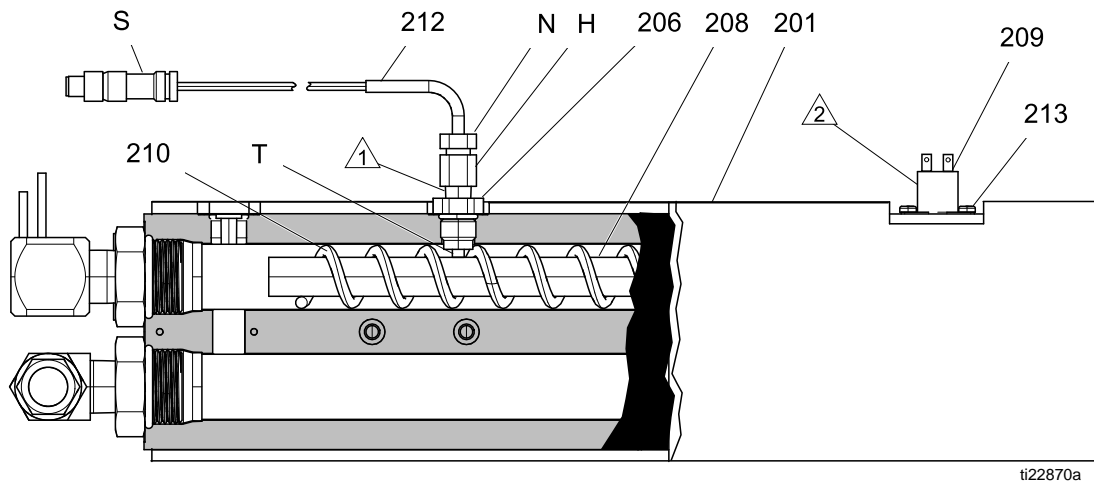

Figure 14

Repair Heated Hose

Refer to the heated hose manual 309572 for hose replacement parts.

Check Hose Heat Power Connectors

1. Perform [Shutdown](#), page 47.

Note

Whip hose must be connected.

2. Disconnect power harness (PM) from hose termination box terminal block (TB).

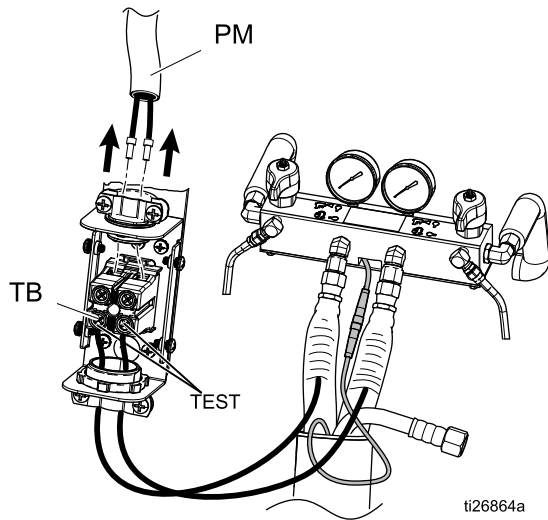

Figure 15

3. For Series A only: Disconnect hose connector (D) at Reactor.

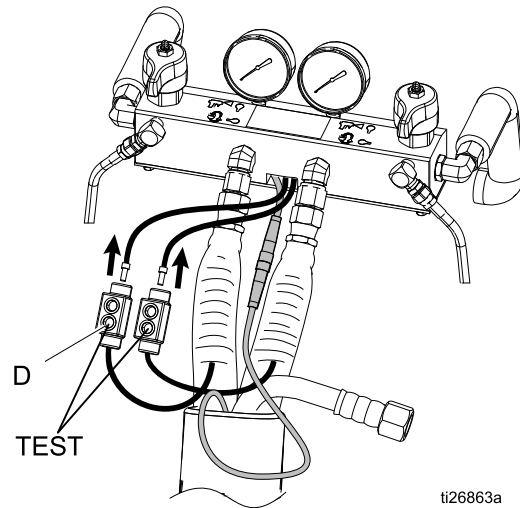

Figure 16

4. Using an ohmmeter, check between the connectors (D). There should be continuity.
5. If hose fails test, retest at each length of hose, including whip hose, until failure is isolated.

Check RTD Cables and FTS

1. Perform [Shutdown](#), page 47.
2. Disconnect RTD cable (C) at Reactor.
3. Test with an ohmmeter between pins of cable connector C.

Note

Do not touch outer ring with test probe.

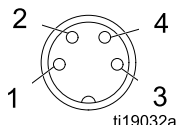

Pins	Result
3 to 1	approximately 1090 ohms
3 to 4	approximately 1090 ohms
1 to 4	0.2 - 0.4 ohms
2 to any	infinity (open)

4. Retest at each length of hose, including whip hose, until failure is located.
5. If the FTS is not reading properly at the end of the hose, connect FTS directly to RTD cable (C) at the manifold.
6. If the FTS reads properly at the manifold but not at the end of the hose, check cable (C) connections. Verify they are tight.

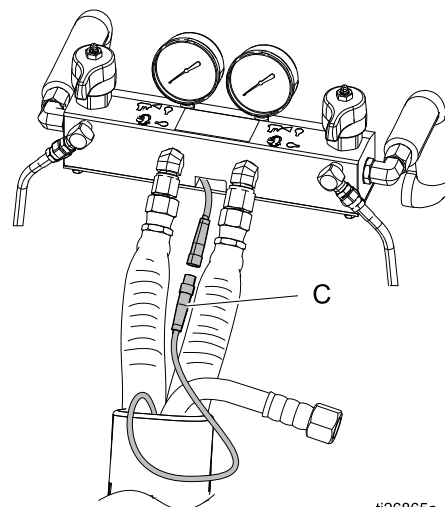

Heated Hose
Figure 17

Note

To assist in taking readings, order RTD Test Kit 24N365. Kit includes two cables: one cable with a compatible female M8 connector and another cable with a male M8 connector. Both cables have stripped wire at the other end for easy test probe access.

Pins / Wire Color	Result
3 to 1 / brown to blue	approximately 1090 ohms
3 to 4 / blue to black	approximately 1090 ohms
1 to 4 / brown to black	0.2 - 0.4 ohms
2 to any / N/A	infinity (open)

Repair Fluid Temperature Sensor (FTS)

Installation

The Fluid Temperature Sensor (FTS) is supplied with the system. Install FTS between main hose and whip hose. See Heated Hose manual 309572 for instructions.

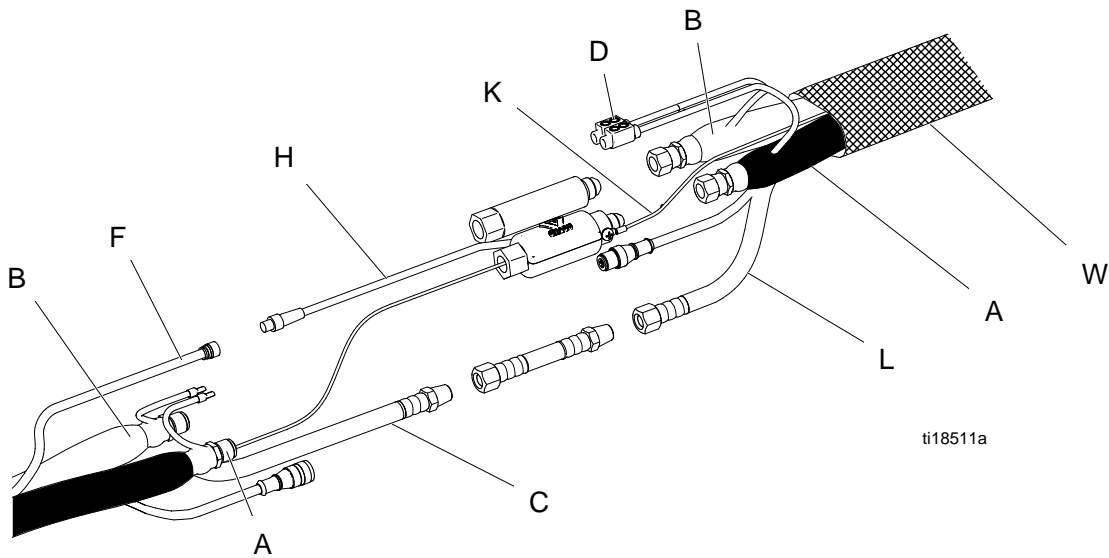

Figure 18

Test/Removal

1. Perform [Shutdown, page 47](#).
2. Remove tape and protective covering from FTS. Disconnect hose cable (F).
3. If FTS is not reading properly at the end of the hose, see [Check RTD Cables and FTS, page 67](#).
4. If FTS fails, replace FTS.

- a. Disconnect air hoses (C,L) and electrical connectors (D).
- b. Disconnect FTS from whip hose (W) and fluid hoses (A, B).
- c. Remove ground wire (K) from ground screw on underside of FTS.
- d. Remove FTS probe (H) from component A (ISO) side of hose.

Transformer Primary Check

See [Electrical Schematics, page 93](#).

1. Check wires and transformer:
 - a. See [Shutdown, page 47](#).
 - b. Shut off CB05.
 - c. Use an ohmmeter to test for continuity between terminals 2 and 4 of CB05. If there is no continuity, check transformer.
2. Check transformer:
 - a. See [Shutdown, page 47](#).
 - b. Remove lower shroud.
 - c. Locate the two smaller (10 AWG) wires, labeled 1 and 2, coming out of transformer. Trace these wires back to terminal blocks TB15 and TB16.
 - d. Use an ohmmeter to test for continuity between two wires; there should be continuity.

Transformer Secondary Check

See [Electrical Schematics, page 93](#).

1. Check wires and transformer:
 - a. Disconnect 7 pin green connector from TCM.
 - b. Use an ohmmeter to test for continuity between terminals 6 and 7 on the TCM 7 pin green connector. There should be continuity. If there is no continuity, check transformer.
 - c. Reconnect 7 pin green connector to TCM
2. Check transformer:
 - a. Remove lower shroud.
 - b. Locate the two larger (6 AWG) wires, labeled 3 and 4, coming out of transformer. Trace these wires back to TB17 and TB18. Open circuit breaker CB01 to turn the color

indicator on the circuit breaker GREEN. Use an ohmmeter to test for continuity between two transformer wires in terminal blocks TB17 and TB18; there should be continuity.

- c. Close the circuit breaker CB01.

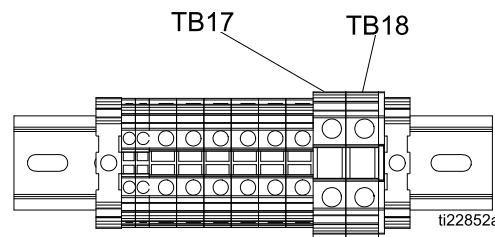
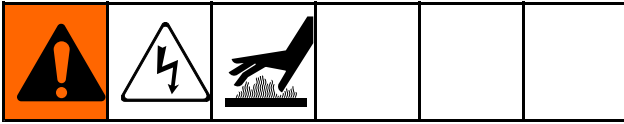

Figure 19

- d. Apply incoming power to system.
- e. To verify voltage on the secondary leads of the transformer, measure between the terminals terminals 3 and 4 on TB17 and TB18. Verify voltage is approximately 90 VAC for 240 VAC input.
- f. See the Diagnostic Run Screen on the ADM. The Diagnostic Run Screen displays the incoming (90 Vac) to the TCM "Hose Voltage". The diagnostic screen will show if the circuit breaker has been tripped for the incoming power to the TCM.

12/20/13 09:00		
Job Data Diagnostic Home		
E-30 Active No Active Errors		
A Chemical	B Chemical	Hose Chemical
70 °F	70 °F	70 °F
A Current	B Current	Hose Current
0 A	0 A	0 A
TCM PCB		
70 °F		
Pressure A	Pressure B	Hose Voltage
0 psi	0 psi	90 V
MCM Bus	CFM	Total Cycles
400 V	0	0

Replace Transformer



1. Perform [Shutdown](#), page 47.
2. Remove four bolts (23) and shroud (10).
3. Remove lower dinrail cover (48).
4. Disconnect fan and transformer connections from terminal blocks. Connections are on left side labeled: V+, V-, 1, 2, 3, and 4.
5. Remove four nuts (27) holding metal transformer cover (8) to frame. Carefully remove cover while sliding wires through hole in cover.
6. Remove nuts (27) and transformer (17).
7. Install transformer (17) in reverse order.

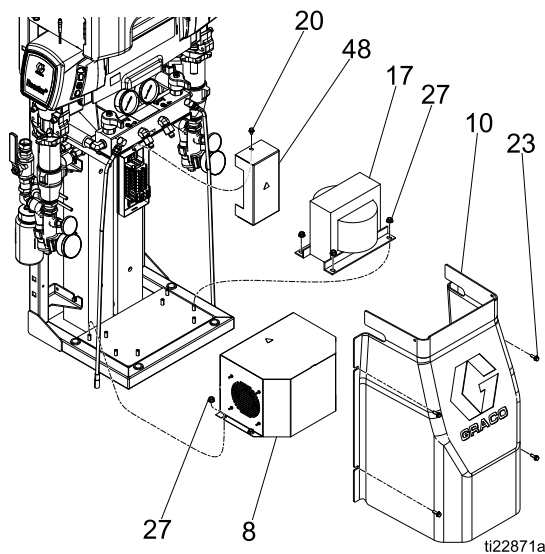
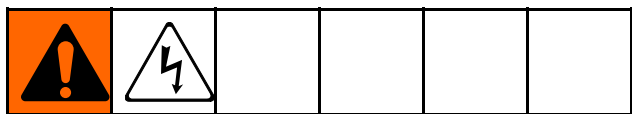

Figure 20

Replace Power Supply



1. Perform [Shutdown](#), page 47.
2. Disconnect input and output cables from both sides of the power supply. See [Electrical Schematics](#), page 93.
3. Insert a flat head screw driver in the mounting tab on the bottom of the power supply to remove from the din rail.
4. Install new power supply (535) in reverse order.

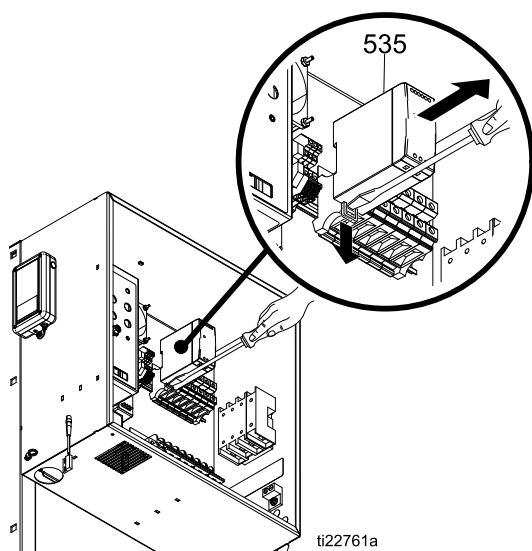

Figure 21 24 VDC Power Supply

Replace Surge Protector

1. Loosen connections on terminals 1 and 3 on CB02.
2. Loosen connections on input to power supply (535) on N and L connections.
3. Remove two screws (413) and surge protector (505) from enclosure.
4. Install new surge protector (505) in reverse order.

Note

Wire on both the circuit breaker and power supply are interchangeable.

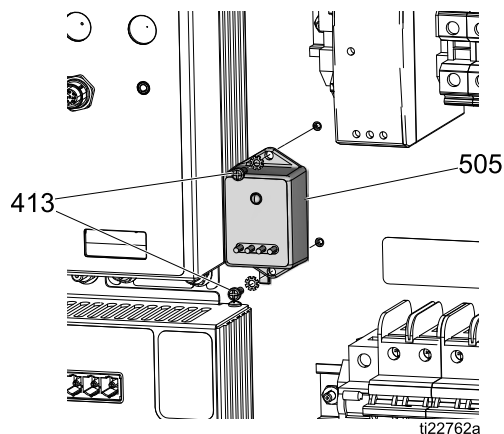

Figure 22 Surge Protector

Replace Advanced Display Module (ADM)

1. Loosen four screws (70) on inside of electrical enclosure door (61). Lift up and pull out to remove ADM (88).
2. Disconnect CAN cable (475).
3. Inspect ADM (88) for damage. Replace if necessary.

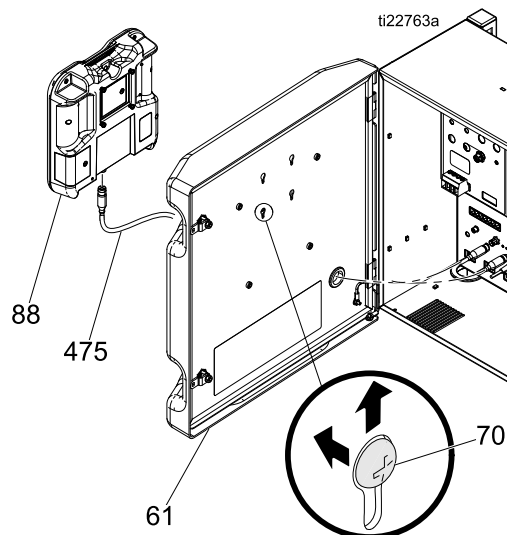

Figure 23

Replace Motor Control Module (MCM)

1. Perform [Shutdown, page 47](#).
2. Disconnect connectors from MCM (63). Disconnect two power cables. See [Electrical Schematics, page 93](#).
3. Remove nuts (91) and MCM (63).
4. Set rotary switch. 2= E-30 and 3= E-XP2.
5. Replace MCM in enclosure.
6. Connect cables to MCM. See [Electrical Schematics, page 93](#).

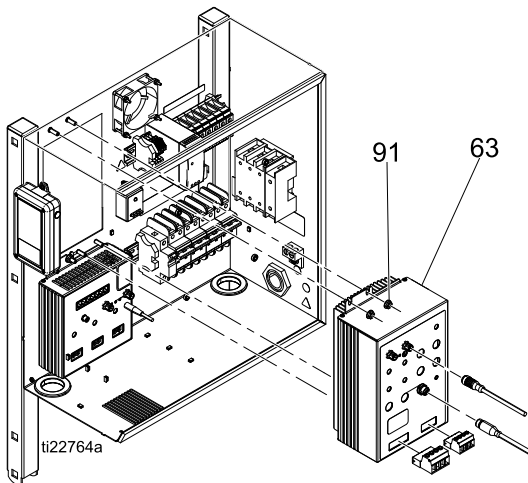

Figure 24 Replace MCM

Replace Temperature Control Module (TCM)

1. Perform [Shutdown, page 47](#).
2. Open electrical enclosure door (61).
3. Disconnect all connectors from the TCM (453).
4. Remove four nuts (461) and TCM (453).
5. Install new TCM module (453). Reassemble parts in reverse order.

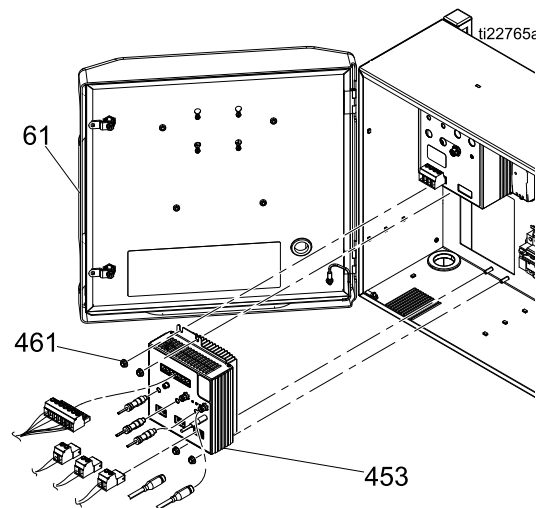

Figure 25 Replace TCM

Software Update Procedure

NOTICE

Repair kit GCA modules are shipped pre-programmed and software loading is not necessary. If software version upgrade is necessary, follow the procedure in the manual provided.

Parts

Proportioners

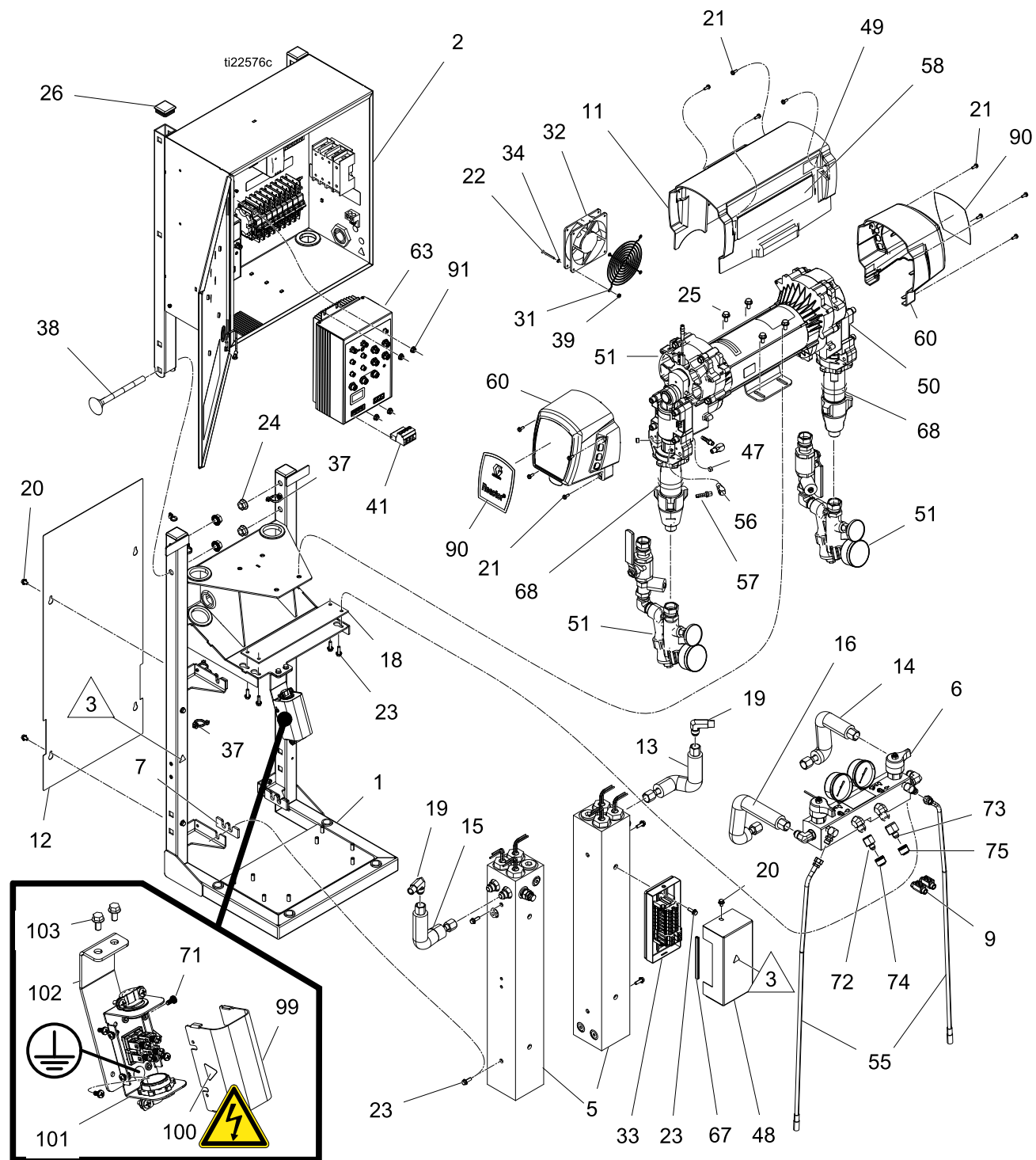

Parts

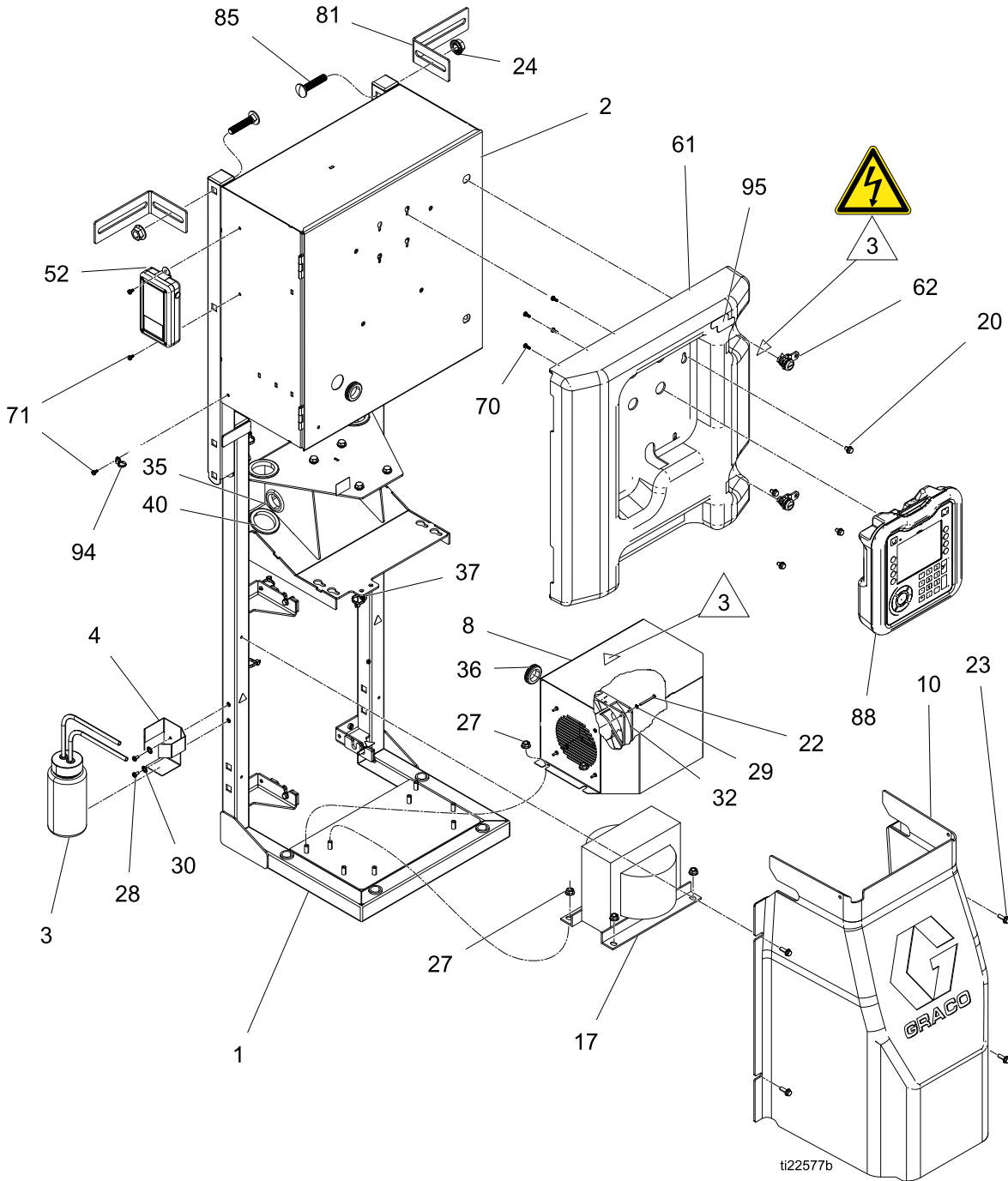

- △1 Apply anaerobic polyacrylate pipe sealant to all non-swiveling pipe threads.
- △2 Apply grease to tube fitting threads. Torque to 43 ft-lbs (58 N•m).
- △3 Safety and warning labels are from label sheet (68).

Ref	Part	Description	Quantity					
			272010	272011	272012	272110	272111	272112
1	- - -	FRAME	1	1	1	1	1	1
2	- - -	ENCLOSURE, electrical; see Electrical Enclosure, page 86	1	1	1	1	1	1
3	246995	BOTTLE, assembly, complete	1	1	1	1	1	1
4	16X531	BRACKET, tsl, bottle	1	1	1	1	1	1
5	24U843	HEATER, 10kw, 2 zone, RTD; see Fluid Heater, page 82	1			1		
	24U842	HEATER, 7.5kw, 1 zone, RTD; see Fluid Heater, page 82		2	2		2	2
6	24U704	MANIFOLD, fluid; see Fluid Manifold, page 84	1	1	1	1	1	1
7	16W654	INSULATOR, foam, heater	2	4	4	2	4	4
8	24R684	COVER, transformer	1	1	1	1	1	1
9+	261821	CONNECTOR, wire, 6awg	1	1	1	1	1	1
10	24U841	COVER, heater	1	1	1	1	1	1
11	16W765	COVER, motor	1	1	1	1	1	1
12	16W764	COVER, heater, rear	1	1	1	1	1	1
13	24U837	TUBE, b-side, inlet, 15 kW		1	1		1	1
	24U838	TUBE, b-side, inlet, 10kw	1			1		
14	24U839	TUBE, b-side, outlet, 15 kW		1	1		1	1
	24U840	TUBE, b-side, outlet, 10kw	1			1		
15	24U834	TUBE, a-side, inlet, 10 kW	1			1		
	24U833	TUBE, a-side, inlet, 15 kW		1	1		1	1
16	24U836	TUBE, a-side, outlet, 10 kW	1			1		
	24U835	TUBE, a-side, outlet, 15 kW		1	1		1	1
17	15K742	TRANSFORMER, 4090va, 230/90	1	1	1	1	1	1
18	15B456	GASKET, manifold	1	1	1	1	1	1

Parts

Ref	Part	Description	Quantity					
			272010	272011	272012	272110	272111	272112
19	125643	FITTING, elbow, 3/8 npt x #8 jic	2	2	2	2	2	2
20	119865	SCREW, mch, hex serrated; 3/8 in. x 1/4-20	9	9	9	9	9	9
21	118444	SCREW, mch, slot hex wash hd; 1/2 in. x #10-24	12	12	12	12	12	12
22	117683	SCREW, mch, phil pan hd; 1.5 in. x #6-32	8	8	8	8	8	8
23	113796	SCREW, flanged, hex hd; 3/4 in. x 1/4-20	11	13	13	11	13	13
24	112731	NUT, hex, flanged	6	6	6	6	6	6
25	111800	SCREW, cap, hex hd; 7/32 in. x 5/16-18	4	4	4	4	4	4
26	111218	CAP, tube, square	2	2	2	2	2	2
27	110996	NUT, hex, flange head	8	8	8	8	8	8
28	104859	SCREW, tapping pnhd; 5/16 in. x #10-16	2	2	2	2	2	2
29	103181	WASHER, lock ext	4	4	4	4	4	4
30	100020	WASHER, lock	2	2	2	2	2	2
31	115836	GUARD, finger	1	1	1	1	1	1
32	24U847	FAN, cooling, 120mm, 24vdc	2	2	2	2	2	2
33	24R685	ENCLOSURE, lower, dinrail; includes 33a-33d	1	1	1	1	1	1
33a	24U849	KIT, module, din rail, heater; see Heater and Transformer Terminal Block Module, page 89	1	1	1	1	1	1
33b	16W667	INSULATOR, FOAM	1	1	1	1	1	1
33c	- - -	COVER, bottom, dinrail	1	1	1	1	1	1
33d	113505	NUT, keps, hex hd	1	1	1	1	1	1
34	151395	WASHER, flat	4	4	4	4	4	4
35	120685	GROMMET	2	2	2	2	2	2
36	114269	GROMMET, rubber	1	1	1	1	1	1
37	125625	TIE, cable, fir tree	5	6	6	5	6	6
38	127277	BOLT, carriage, 1/2-13 x 3.5 l	4	4	4	4	4	4
39	127278	NUT, keps, hex	4	4	4	4	4	4
40	127282	GROMMET, rubber	4	4	4	4	4	4

Ref	Part	Description	Quantity					
			272010	272011	272012	272110	272111	272112
41	16X095	CONNECTOR, power, male, 4 pin	1	1	1	1	1	1
42	125871	TIE, cable, 7.5 in.	25	25	25	25	25	25
43	24K207	KIT, fts, rtd, single hose	1	1	1	1	1	1
44	24R725	BRIDGE, plug-in jumper, ut35	4	4	4	4	4	4
45	106569	TAPE, electrical	1	1	1	1	1	1
46●	24T242	CABLE, over-temp, 10 kW Reactor	1			1		
	24P970	CABLE, over-temp, 15 kW Reactor		1	1		1	1
47	104765	PLUG, pipe headless	2	2	2	2	2	1
48	16V268	COVER, top, dinrail	1	1	1	1	1	1
49	15Y118	LABEL, made in the USA	1	1	1	1	1	1
50	24V150	PROPORTIONER, module, E-30; see Proportioner Module, page 80	1	1		1	1	
	24V151	PROPORTIONER, module, E-XP2; see Proportioner Module, page 80			1			1
51	24U321	KIT, asm, pair, elite, reactor; see Fluid Inlet Kits, page 91				1	1	1
	24U320	KIT, assembly, pair, std, reactor; see Fluid Inlet Kits, page 91	1	1	1			
52●◆	16X118	MODULE, cellular, gps, temp				1	1	1
53●◆	24T050	CABLE, m8 4p f to m12 8p m 1.5m				1	1	1
54●	16W130	CABLE, m12 5p, fem - male, 2.0m				2	2	2
55	24U845	TUBE, pressure relief	2	2	2	2	2	2
56	191892	FITTING, elbow, street, 90 deg; 1/8 npt	2	2	2	2	2	2
57	116746	FITTING, barbed, plated; 1/8-27 npt x 1/4 in. hose I.D.	2	2	2	2	2	2

Parts

Ref	Part	Description	Quantity					
			272010	272011	272012	272110	272111	272112
58	16W218	LABEL, branding, e-30	1	1				
	16W321	LABEL, branding, e-30, elite				1	1	
	16W215	LABEL, branding, e-xp2			1			
	16W322	LABEL, branding, e-xp2, elite						1
59	16U530	MODULE, system surge protector (spare)	1	1	1	1	1	1
60	15G349	COVER, drive, plastic	2	2	2	2	2	2
61	16W766	COVER, control, box	1	1	1	1	1	1
62	16W596	LATCH, door	2	2	2	2	2	2
63	24U832	MODULE, MCM				1	1	1
	24U831	MODULE, MCM	1	1	1			
64	206995	FLUID, tsl, 1 qt.	1	1	1	1	1	1
65	206994	FLUID, tsl 8 oz bottle	1	1	1	1	1	1
67	114225	TRIM, edge protection; 1.6 ft (0.48 m)	1	1	1	1	1	1
68	16X250	LABEL, identification	1	1	1	1	1	1
70	127296	SCREW, mchn, pnh, w/ext tooth wash; M4 x 0.7	4	4	4	4	4	4
71	16X129	SCREW, mach, phillips, tooth wash; 5/16 x 8-32	10	10	10	10	10	10
72	117502	FITTING, reducer #5 x #8 (JIC)	1	1	1	1	1	1
73	117677	FITTING, reducer #6 x #10 (JIC)	1	1	1	1	1	1
74	299521	CAP, 1/2-20 jic cap-aluminum	1	1	1	1	1	1
75	299520	CAP, 9/16-18 JIC cap-aluminum	1	1	1	1	1	1
79+	261843	FLUID, oxide inhibitor	1	1	1	1	1	1
81	16V806	BRACKET, wall, mount	2	2	2	2	2	2
82	15V551	SHIELD, membrane, ADM (10 pack)	1	1	1	1	1	1
83	24K409	BAR, 55 gal chem. measure; A side	1	1	1	1	1	1
84	24K411	BAR, 55 gal chem. measure. B side	1	1	1	1	1	1

Ref	Part	Description	Quantity					
			272010	272011	272012	272110	272111	272112
85	127276	BOLT, carriage, 1/2-13 x 2.5 l	2	2	2	2	2	2
88	24U854	MODULE, ADM	1	1	1	1	1	1
89	16W967	FITTING, swivel, 3/4 npt x 1 npsm	2	2		2	2	
	118459	FITTING, union, swivel, 3/4 in.			2			2
90	16W213	LABEL, branding, reactor	2	2	2	2	2	2
91	115942	NUT, hex, flange head	4	4	4	4	4	4
92●	15D906	SUPPRESSOR, round snap ferrite .260	1	1	1	1	1	1
93	127368	SLEEVE, split, wire, 1.50 ID	2	2	2	2	2	2
94	127377	TIE, cable, 6 in.				1	1	1
95	16X154	LABEL, InSite				1	1	1
96	333091	MANUAL, quick guide, startup	1	1	1	1	1	1
97	333092	MANUAL, quick guide, shutdown	1	1	1	1	1	1
98*	24W204	ENCLOSURE, terminal block	1	1	1	1	1	1
99*	25A234	ENCLOSURE, cover	1	1	1	1	1	1
100*	189930	LABEL, caution	1	1	1	1	1	1
101*	172953	LABEL, ground	1	1	1	1	1	1
102*	17D955	BRACKET, mounting	1	1	1	1	1	1
103*	113161	SCREW, flange, hex hd	2	2	2	2	2	2

Replacement Warning labels, signs, tags, and cards are available at no cost.

Not shown.

◆ Parts included in Graco Insite Kit 24T280.

● See [Electrical Schematics, page 93](#).

+ Part applies to Series A only.

* Part applies to Series B only.

Proportioner Module
24V150, Module for E-30
24V151, Module for E-XP2

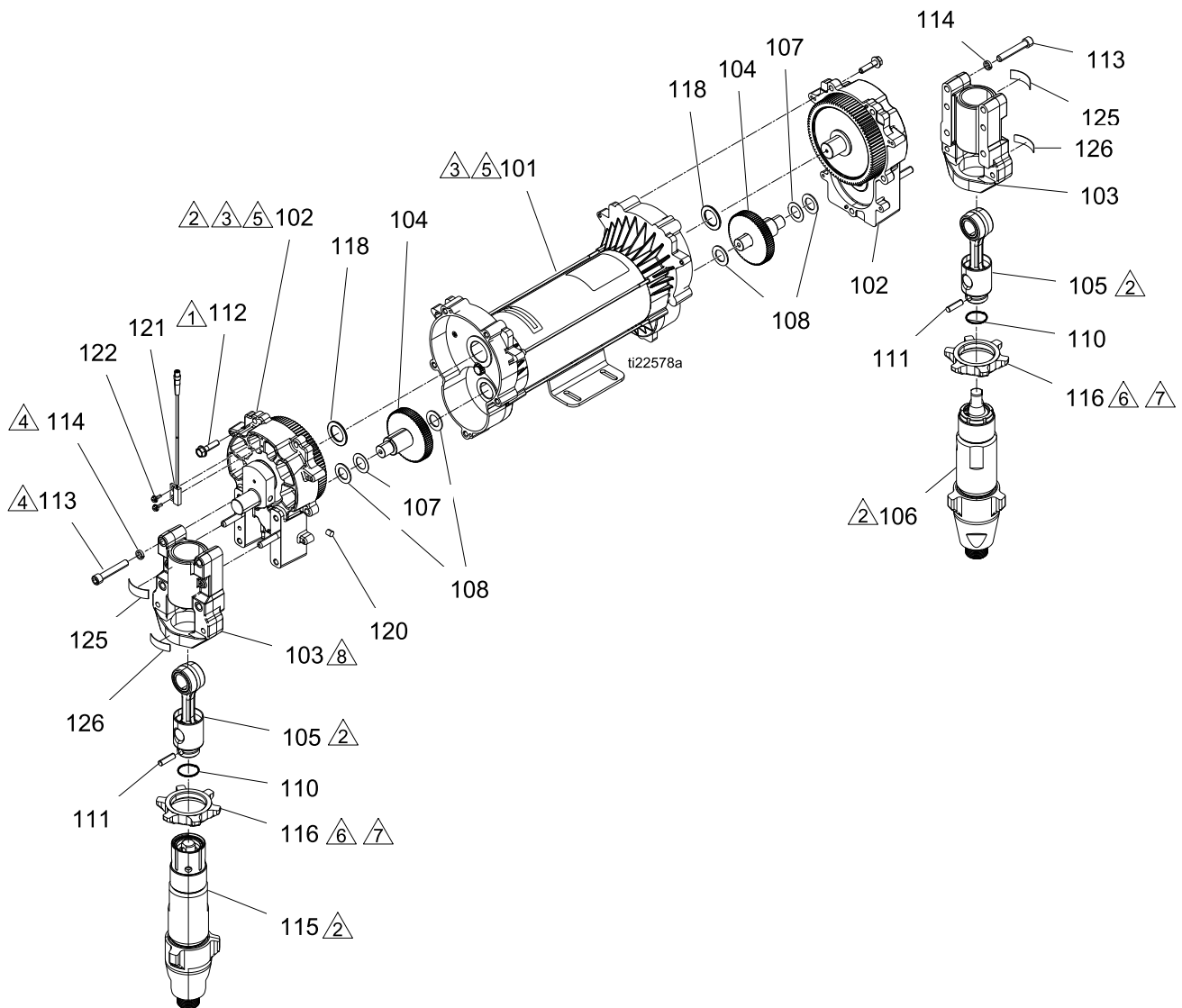

- 1 Torque to 190–120 in-lbs (21–24 N•m).
- 2 Lubricate threads with ISO oil or grease. Assemble pump cylinders flush to one full thread under-flush of housing surface.
- 3 Apply grease to all gear teeth proportionally, motor pinion and drive housing.
- 4 Torque to 20–30 ft-lbs (27–40.6 N•m).
- 5 Crankshaft must be in line with crankshaft at other end of motor.
- 6 Torque to 70–80 ft-lbs (95–108 N•m).
- 7 Flat side faces up.

Ref	Part	Description	24V150 E-30	24V151 E-XP2
101	24U050	MOTOR, brushless, double ended, 2 HP	1	1
102❖	24M417	HOUSING, drive, Mark VII	2	2
103	257355	HOUSING, bearing		2
	245927	HOUSING, bearing	2	
104■	287290	KIT, repair, gear	2	2
105●	241279	KIT, rod, connecting	2	2
106	245971	PUMP, displacement B		1
	245972	PUMP, displacement B	1	
107■	114699	WASHER, thrust; steel colored	2	2
108■	114672	WASHER, thrust; copper colored	4	4
110●	183169	SPRING, retaining	2	2
111	183210	PIN, str, hdls	2	2
112❖	15C753	SCREW, machine, hex wash hd; 1.25 in. x 5/16–18	10	10
113	114666	SCREW, cap, socket head; 2.25 x 3/8–16	8	8
114	106115	WASHER, lock (hi-collar)	8	8
115	246831	PUMP, displacement, A		1
	246832	PUMP, displacement, A	1	
116	193031	NUT, retaining		2
	193394	NUT, retaining	2	
118❖	116192	WASHER, thrust (1595)	2	2
120	116618	MAGNET	1	1
121	24P728	SWITCH, reed, M8 4-pin	1	1
122	127301	SCREW, hexhead, thread cut, 4-40 x 0.375	2	2
125	187437	LABEL, torque	2	2
126	192840	LABEL, warning	2	2

Replacement Warning labels, signs, tags, and cards are available at no cost.

See pump repair manual 309577 for repair kits.

- Spring (110) included in Connecting Rod Kit 241279.

■ Gear Repair Kit includes washers (107) and (108).

❖ Drive Housing Repair Kit includes housing (1), screws (5), and washer (1) to replace one end.

Fluid Heater

24U843 — 10kW, 2-zone

24U842 — 7.5 kW, 1-zone

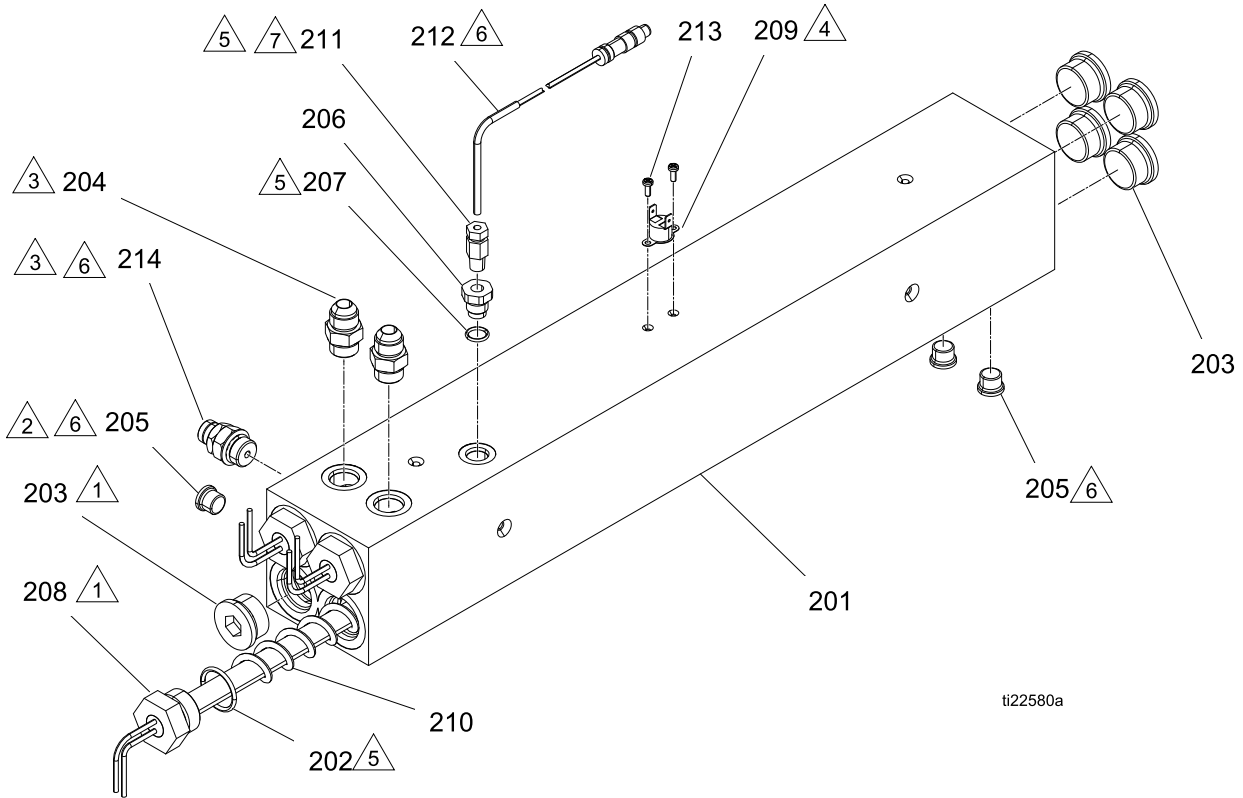

ti22580a

- 1 Torque to 120 ft-lbs (163 N•m).
- 2 Torque to 23 ft-lbs (31 N•m).
- 3 Torque to 40 ft-lbs (54 N•m).
- 4 Apply thermal paste.
- 5 Apply pipe sealant and PTFE tape to all non-swiveling threads and threads without o-rings.
- 6 Apply lithium grease lubricant to o-rings before assembling in block (1).
- 7 Remove tape from probe tip and Orientate sensor as shown. Insert probe until it bottoms on heating element. Tighten ferrule on sensor probe one turn past finger tight or 16 ft-lbs (21.6 N•m).



Ref	Part	Description	24U843	24U842
201	15J090	HEATER, machined, 1 zone		1
	15K825	HEATER, machined, dual zone	1	
202	124132	O-RING	4	3
203	15H305	FITTING, plug, hollow, hex, 1-3/16 sae	4	5
204	121309	FITTING, adapter, sae-orb x jic	4	2
205	15H304	FITTING, plug 9/16 sae	2	3
206	15H306	ADAPTER, 9/16 x 1/8	2	1
207	120336	O-RING, packing	2	1
208	16A110	HEATER, immersion, 2550W, 230V	4	3
209	15B137	SWITCH, over temperature	1	1
210	15B135	MIXER, immersion heater	4	3
211*	- - -	FITTING, compression	2	1
212*	- - -	SENSOR, RTD	2	1
213	124131	SCREW, machine, pnhd; 5/16 in. x #6-32	2	2
214	247520	HOUSING, rupture disc	2	1

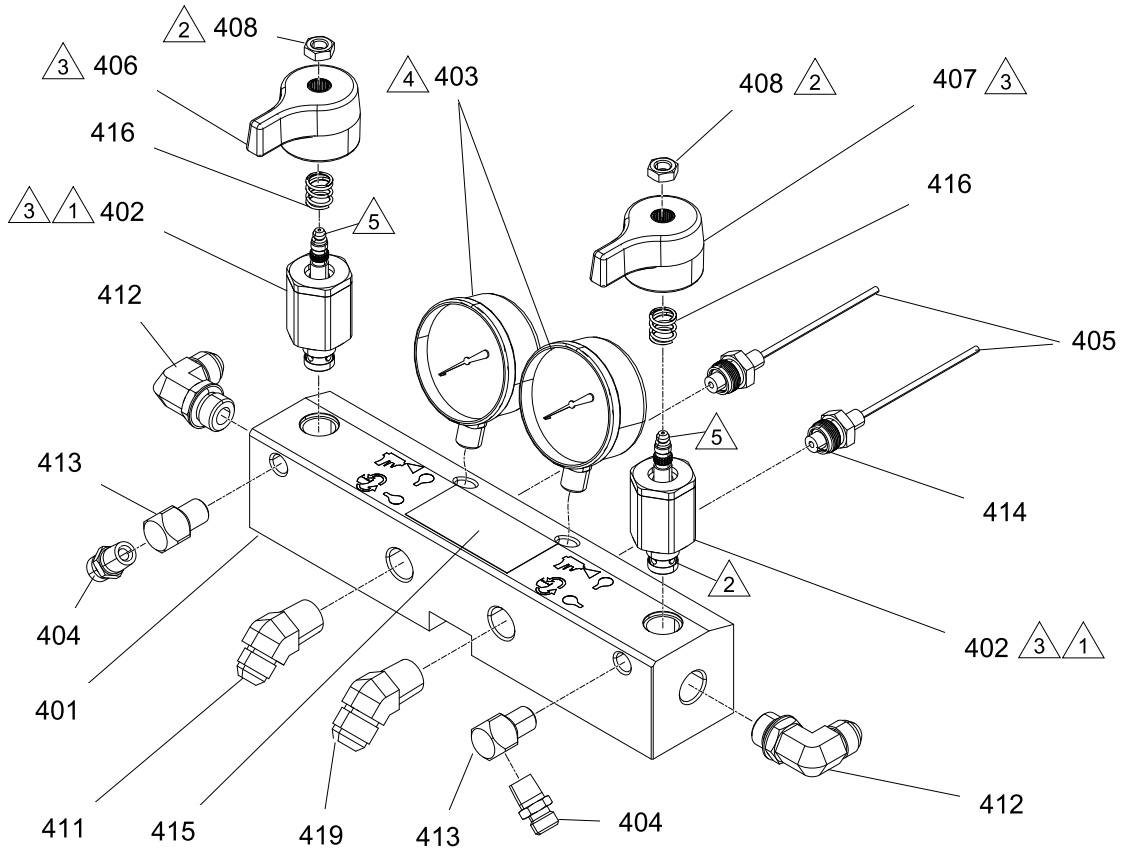

* Included in 24L973 Heater RTD Repair Kit.

Fluid Manifold 24U844



ti22968a

-  Torque to 355–395 in.-lbs (40–44.6 N•m)
-  Apply sealant (113500) to threads.
-  Valve must be closed with handle position as shown on drawing.

-  Apply PTFE tape and thread sealant to gauge threads.
-  Apply grease on valve.
- **** Apply PTFE tape or thread sealant to tapered threads.

24U844, Fluid Manifold

Ref	Part	Description	Qty	Ref	Part	Description	Qty
401	255228	MANIFOLD, fluid	1	413	100840	FITTING, elbow, street	2
402	247824	KIT, valve, cartridge, drain	2	414	111457	O-RING, PTFE	2
402a	158674	O-RING, BUNA-N	1	415	189285	LABEL, caution	1
402b	247779	SEAL, seat, valve	1	416	150829	SPRING, compression	2
403	102814	GAUGE, press, fluid	2	419	117557	NIPPLE, #10 JIC x 1/2 NPT	1
404	162453	FITTING, 1/4 NPSM X 1/4 NPT	2	<i>Replacement Warning labels, signs, tags, and cards are available at no cost.</i> <i>Included in the following complete valve kits: ISO Valve Kit (left/red) handle 255149. Resin Valve Kit (right/blue handle) 255150. Valve Set Kit (both handles and grease gun) 255148.</i>			
405	15M669	SENSOR, pressure, fluid outlet	2				
406	247788	HANDLE, red	1				
407	247789	HANDLE, blue	1				
408	112309	NUT, hex, jam	2				
411	117556	NIPPLE, #8 JIC x 1/2 NPT	1				
412	121312	FITTING, elbow, 3/4 SAE x 1/2 JIC	1				

Electrical Enclosure

Ref	Part	Description	Qty	Ref	Part	Description	Qty
451	24U087	ENCLOSURE	1	468	111218	CAP, tube, square	2
453	24U855	MODULE, TCM	1	469	114269	GROMMET, rubber	1
454	24U848	FAN, cooling, 80 mm, 24VDC	1	470	127282	GROMMET, rubber	2
455	24R736	SWITCH, disconnect, door mounted	1	471	127278	NUT, keps, hex	4
457	117666	TERMINAL, ground	1	472	16W925	GASKET, enclosure, foam	2
458	120859	NUT, strain relief, M40 thread	1	473	16W926	GASKET, enclosure, foam	2
459	120858	BUSHING, strain relief, M40 thread	1	474	24R735	CABLE, CAN power, M12 female, pigtail	1
460	123967	KNOB, operator disconnect	1	475	127068	CABLE, CAN, female/female 1.0 meter	2
461	115942	NUT, hex, flange head	5	476	24U850	MODULE, breaker	1
462	103181	WASHER, lock external	2	477	127290	CABLE, 4-pin, male/female, 1.3 meter, molded (hose RTD)	1
463	124131	SCREW, machine, pan head; 5/16 in. x #6-32	2	478	16X050	LABEL, safety; enclosure	1
464	194337	WIRE, grounding, door	1	479	16X049	LABEL, safety; multi	1
466	113505	NUT, keps, hex head	6				

Replacement Warning labels, signs, tags, and cards are available at no cost.

See [Electrical Schematics, page 93](#).

System DIN Rail and Harness Module Kit 24U850, System DIN Rail and Harness Module Kit

See [Electrical Schematics, page 93](#).

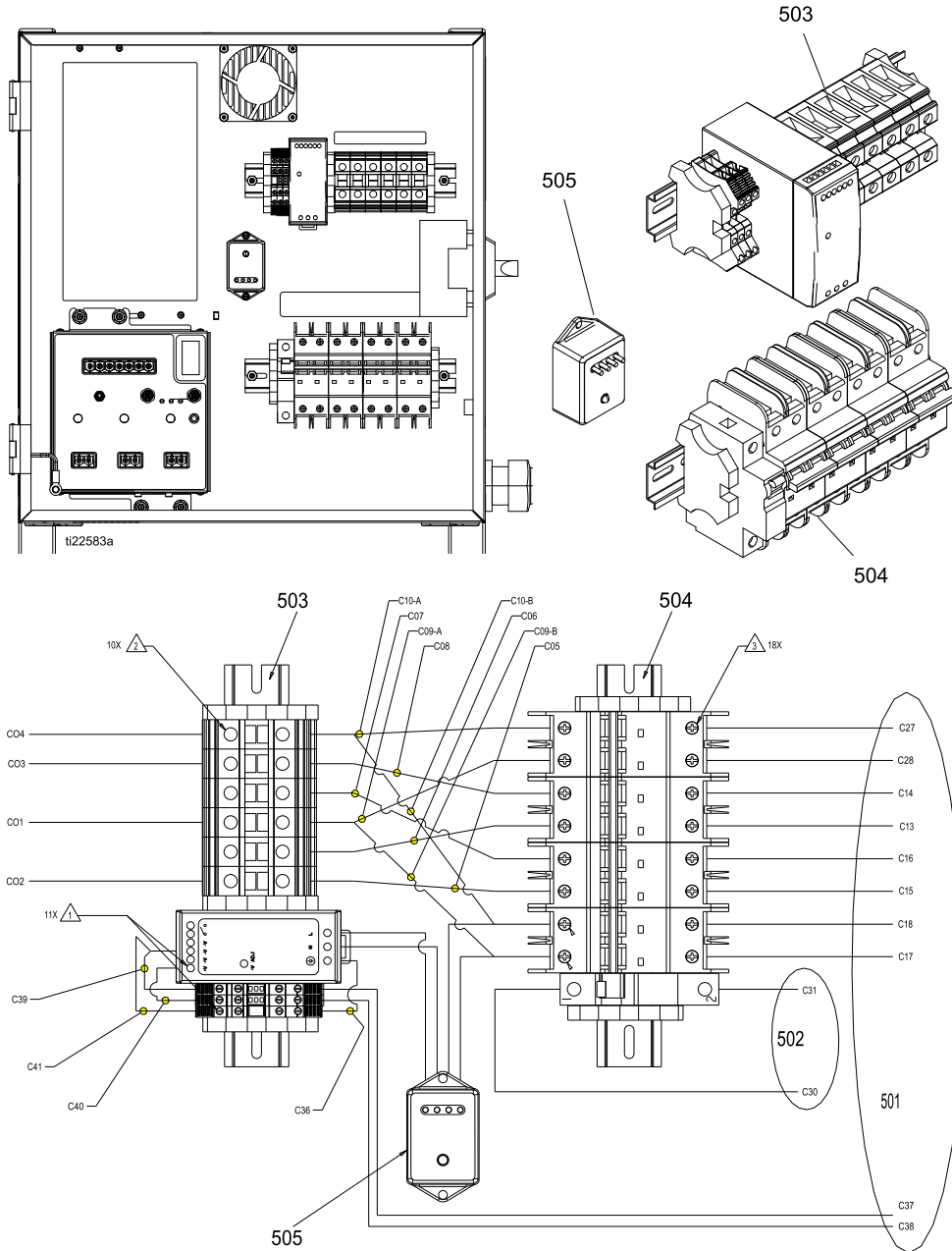

- 1 Torque to 6–8 in.-lbs (0.7–1 N•m)
- 2 Torque to 28–33 in.-lbs (3–3.8 N•m)
- 3 Torque to 23–26 in.-lbs (2.6–3 N•m)

Ref	Part	Description	Qty	Ref	Part	Description	Qty
501	16U529	HARNESS, breaker module	1	504	16U526	MODULE, din rail, circuit breakers; see Power Supply and Terminal Block Module, page 90	1
502	16V515	HARNESS, hose out	1				
503	16U522	MODULE, din rail, term blk, power sup; see System Circuit Breaker Module, page 90	1	505	16U530	MODULE, sys surge protector	1

Heater and Transformer Terminal Block Module 24U849

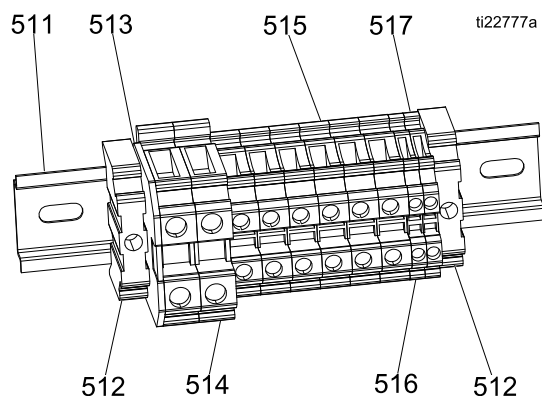

Ref	Part	Description	Qty	Ref	Part	Description	Qty
511	24T315	RAIL, DIN; 35 mm x 7.5 mm x 7 in.	1	515	120570	BLOCK, terminal	6
512	126811	BLOCK, clamp, end	2	516	24R758	BLOCK, terminal, UT-2.5, red	1
513	126383	COVER, end	1	517	24R759	BLOCK, terminal, UT-2.5, black	1
514	126382	BLOCK, terminal	2				

System Circuit Breaker Module 16U526

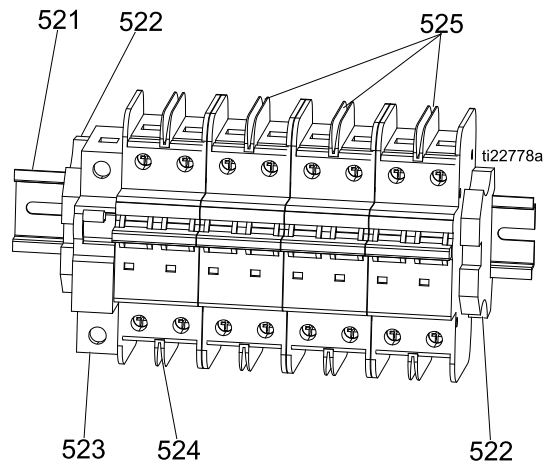

Ref	Part	Description	Qty	Ref	Part	Description	Qty
521	514014	RAIL, DIN; 35 mm x 7.5 mm x 8.625 in.	1	524	17A314	CIRCUIT, breaker, 2P, 20A, UL489	1
522	120838	TERMINAL, end stop	2	525	17A317	CIRCUIT, breaker, 2P, 40A, UL489	3
523	17A319	CIRCUIT, breaker, 1 pole, 50A, C Curve	1				

Power Supply and Terminal Block Module 16U522

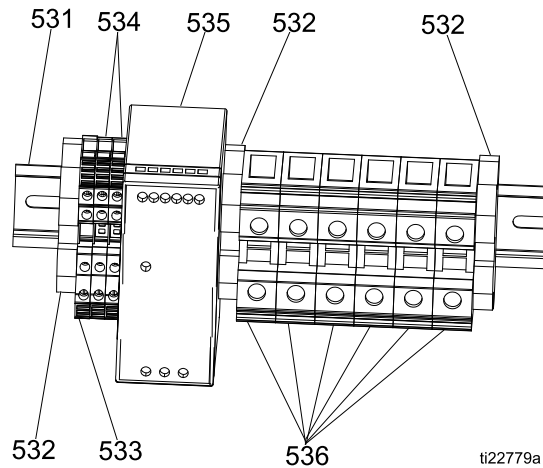

Ref	Part	Description	Qty	Ref	Part	Description	Qty
531	514014	RAIL, DIN; 35 mm x 7.5 mm x 8.625 in.	1	534	24R723	BLOCK, terminal, quad M4, ABB	2
532	120838	TERMINAL, end stop	3	535	126453	POWER SUPPLY, 24V	1
533	24R722	BLOCK, terminal PE, quad, ABB	1	536	24R724	BLOCK, terminal, UT35	6

Fluid Inlet Kits

24U320, Standard
24U321, Elite

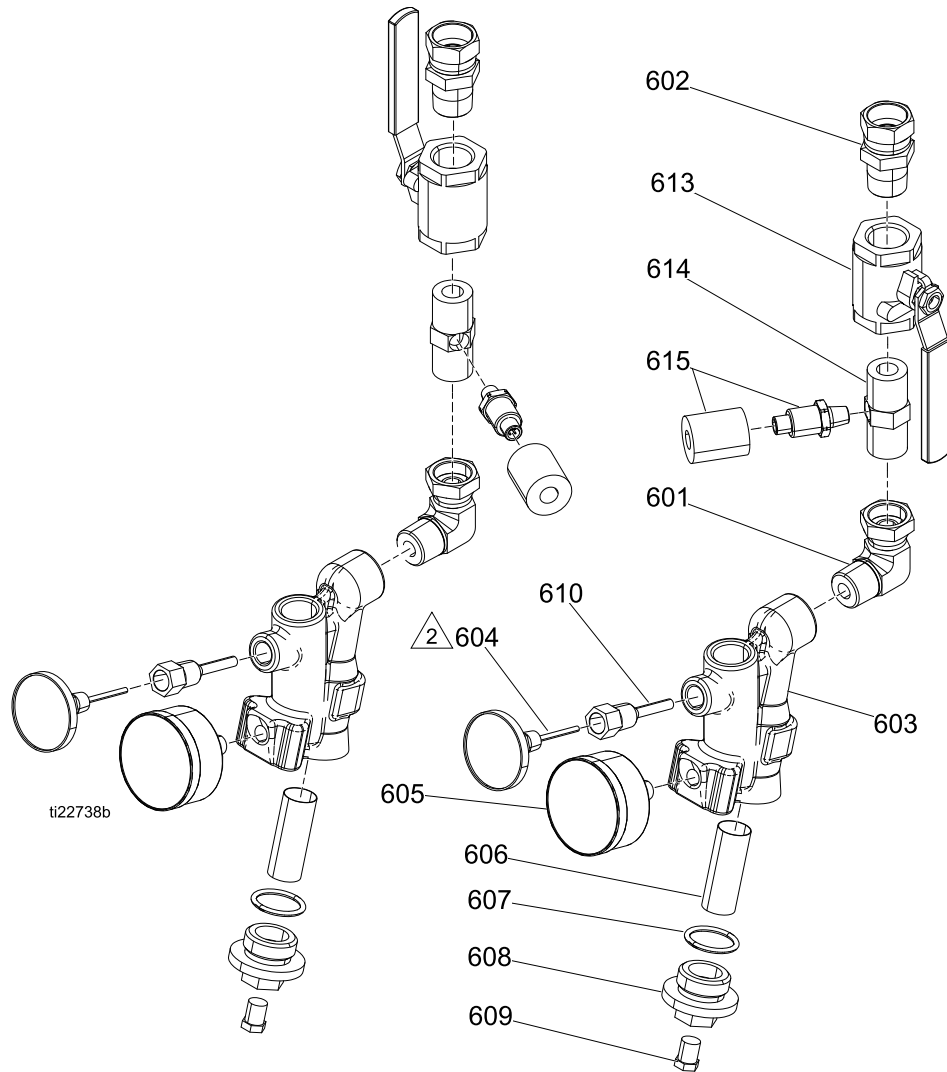

- △ 1 Apply sealant to all tapered pipe threads. Apply sealant to female threads. Apply to at least the first four threads and approximately 1/4 turn wide.
- △ 2 Apply thermal paste to the stem of dial before assembling into housing.

Parts

Ref	Part	Description	Quantity	
			24U320	24U321
601	160327	FITTING, union adapter, 90°	2	2
602	118459	FITTING, union, swivel, 3/4 in.	2	2
603◆	247503	MANIFOLD, strainer, inlet	2	2
604	24U852	THERMOMETER, dial	2	2
605	24U853	GAUGE, press, fluid	2	2
606	- - -	FILTER, replacement	2	2
607 ◆	C20203	PACKING, o-ring, 1.17, fluoroelastomer	2	2
608◆	16V879	CAP, filter	2	2
609◆	555808	PLUG, 1/4mp w/ hex hd	2	2
610	15D757	HOUSING, thermometer, viscon hp	2	2
613	109077	VALVE, ball 3/4 npt	1	2
614	C20487	FITTING, nipple, hex	2	
614	624545	FITTING, tee 3/4m run x 1/4f branc		2
615	24U851	TRANSDUCER, pressure, temperature (includes foam)		2

* *Optional 80 mesh filter 255082 (2 pack)*

★ *Included in 24V020 Inlet Filter and Seal Kit, 20 mesh (2 pack).*

◆ *Included in 247503 Manifold Repair Kit.*

Electrical Schematics

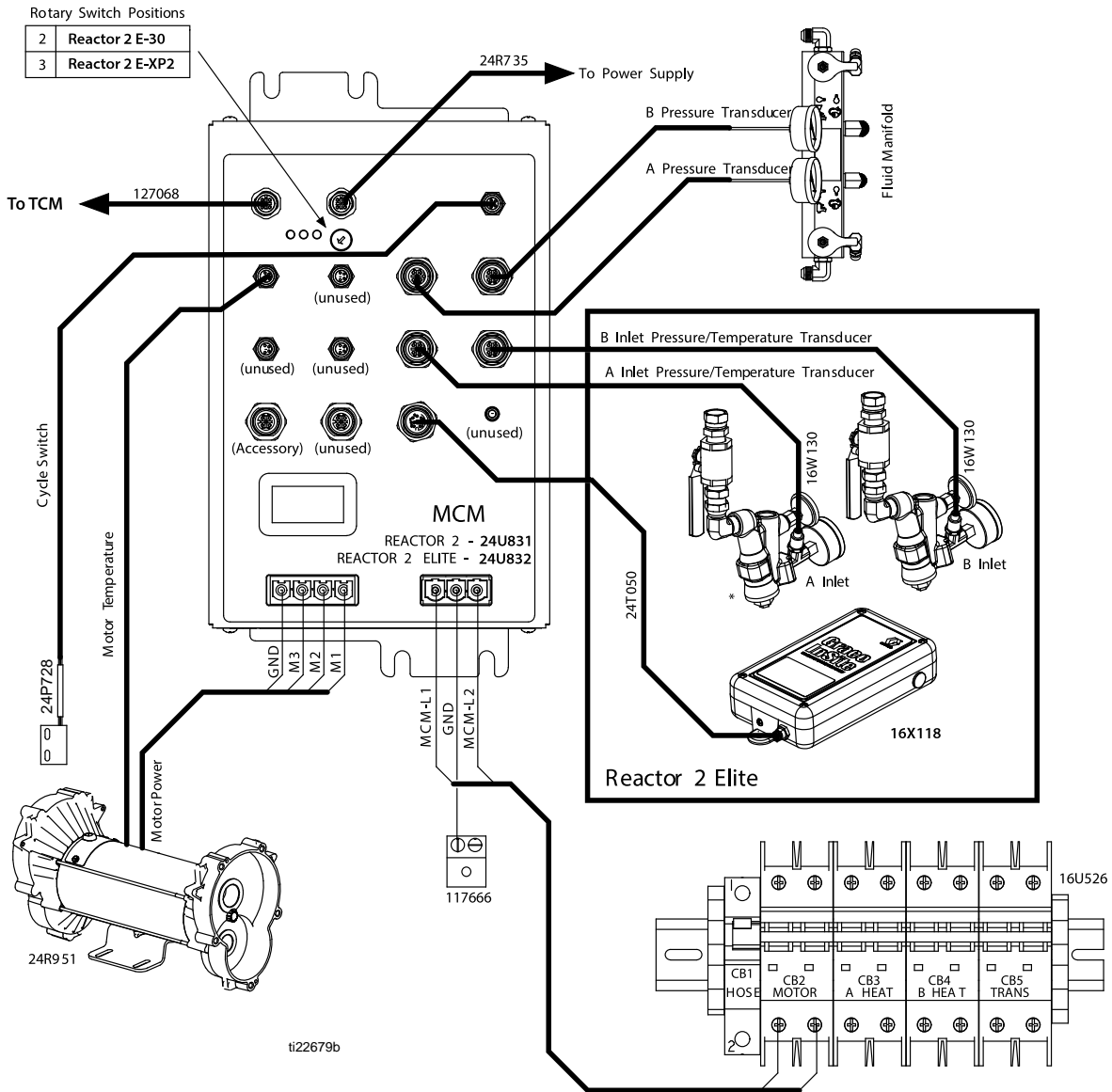

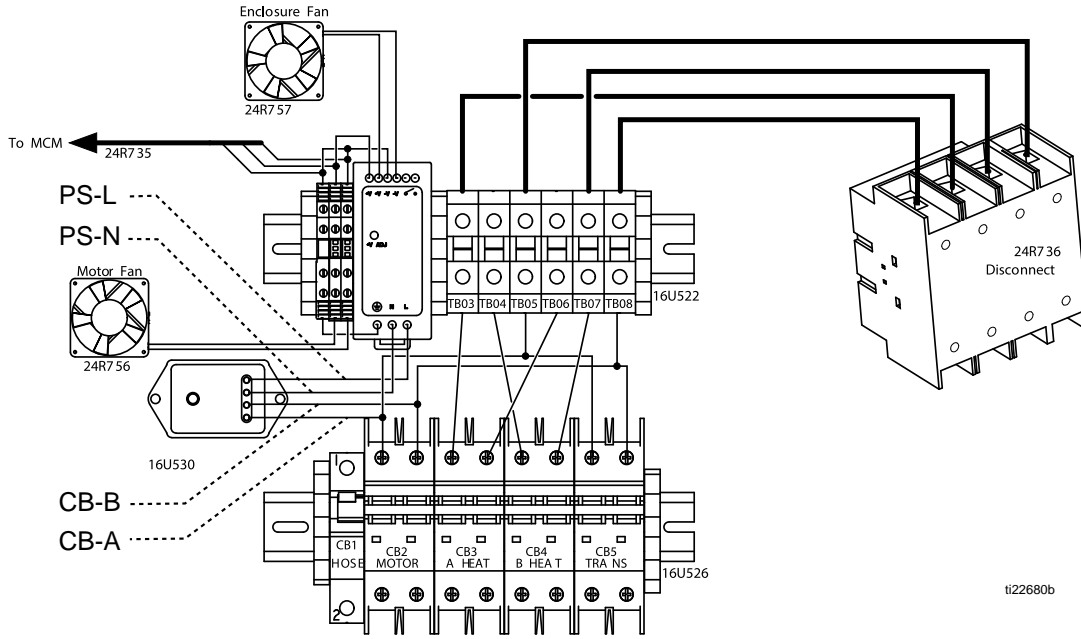

t122680b

INCOMING POWER DIAGRAM

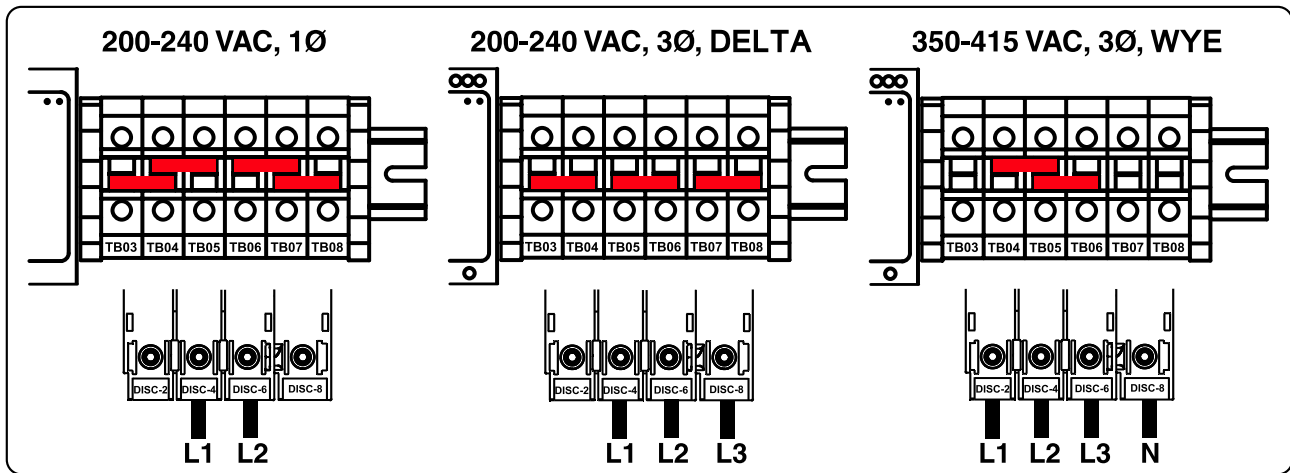

16X050A

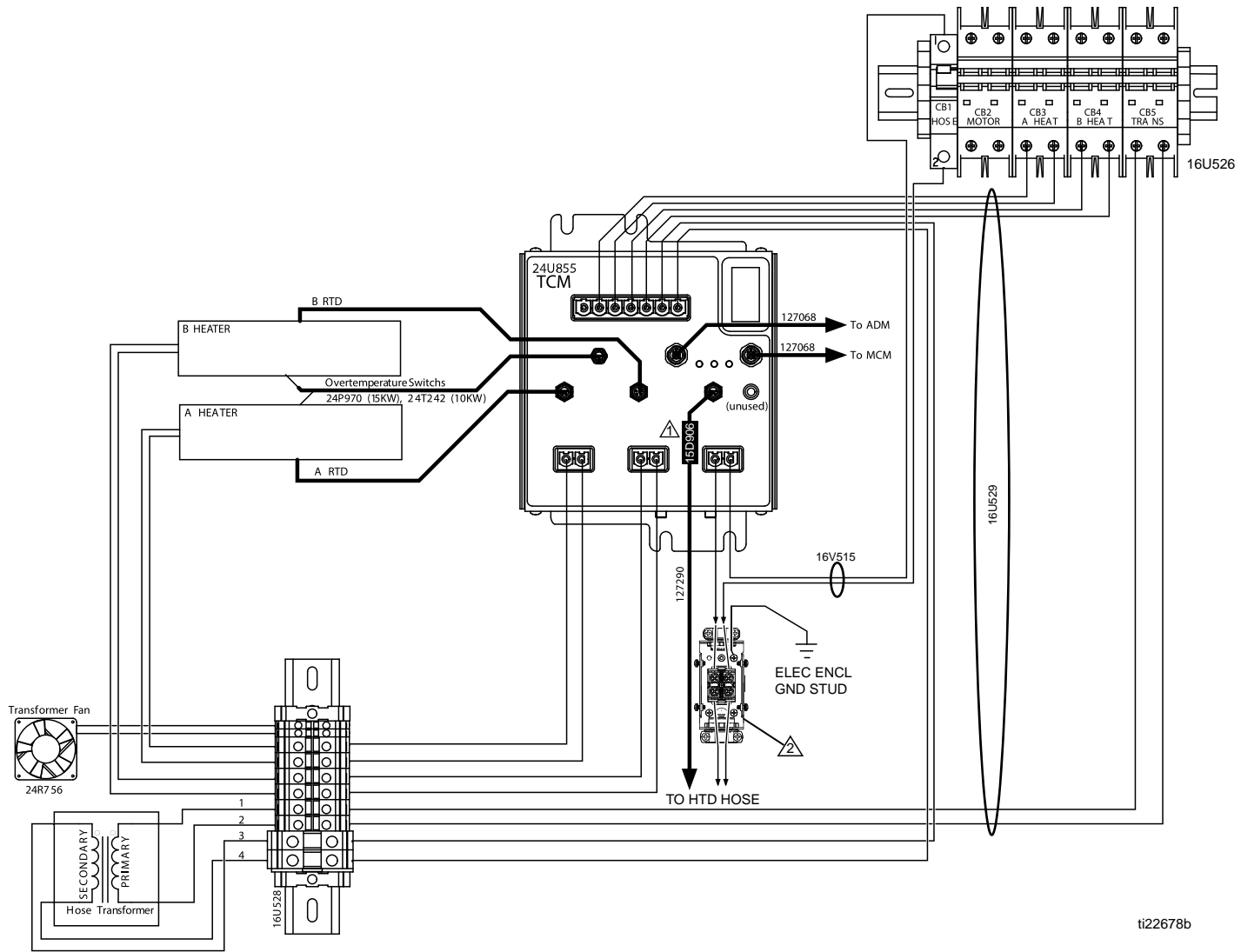

ti22678b

- 1 Locate near TCM.
- 2 Heated hose wire termination enclosure (series B only).

Reactor 2 Repair Spare Parts Reference

Recommended Common Spare Parts

Ref	Part	Description	Part of Assembly
106, 115	15C852	E-30 Pump Repair Kit	Pump
106, 115	15C851	E-XP2 Pump Repair Kit	Pump
106, 115	246963	E-XP2 Wet Cup Repair Kit	Pump
106, 115	246964	E-30 Wet Cup Repair Kit	Pump
606, 607	24V020	Y-Strainer Filter and Gasket Kit (pack of two each)	Y-Strainer
402	247824	Drain Valve Cartridge	Fluid Manifold
403	102814	Fluid Pressure Gauge	Fluid Manifold
405	15M669	Pressure Sensor	Fluid Manifold
211, 212	24L973	RTD Repair Kit	Heater
--	24K207	Hose FTS	Hose
--	24N450	RTD Cable (50 ft. replacement)	Hose
--	24N365	RTD Cable Test Kit (To assist measuring RTDs and RTD cable resistances)	Hose

Performance Charts

Use these charts to help identify the proportioner that will work most efficiently with each mix chamber. Flow rates are based on a material viscosity of 60 cps.

NOTICE
 To prevent system damage, do not pressurize the system above the line for the gun tip size being used.

Proportioners For Foam

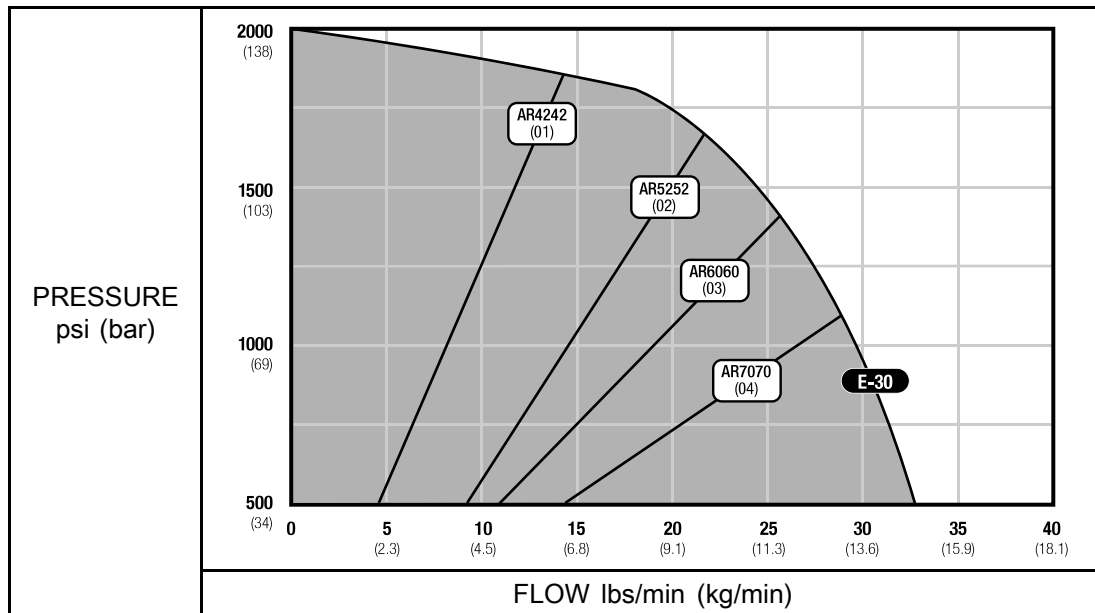

Proportioners For Coatings

Table 1 Fusion Air Purge, Round Pattern

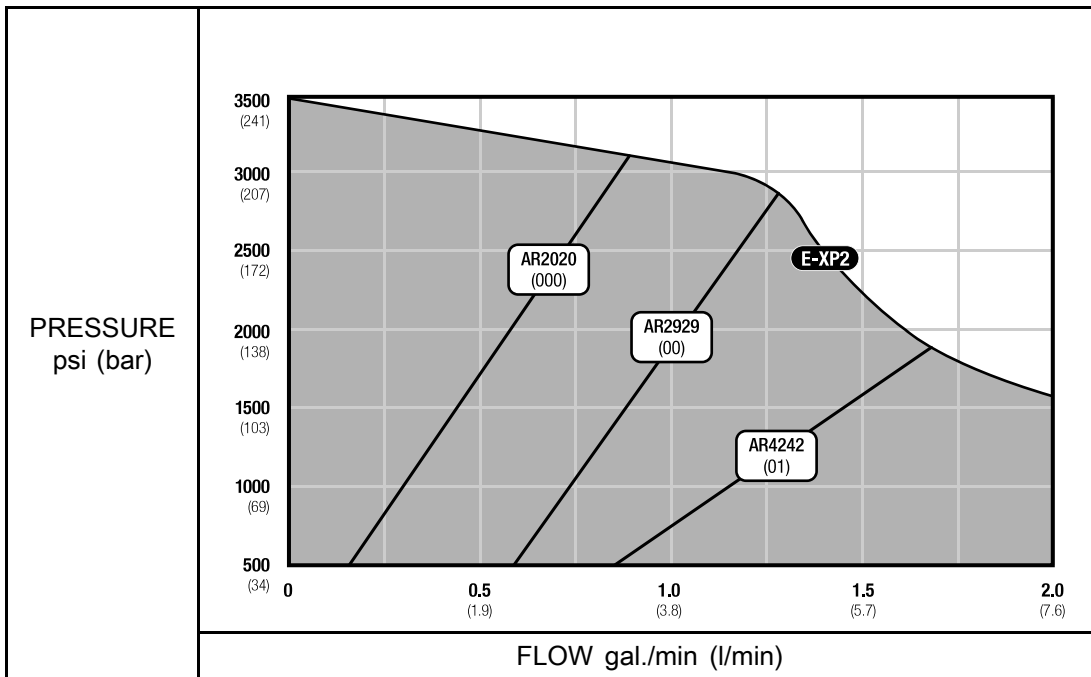

Table 2 Fusion Air Purge, Flat Pattern

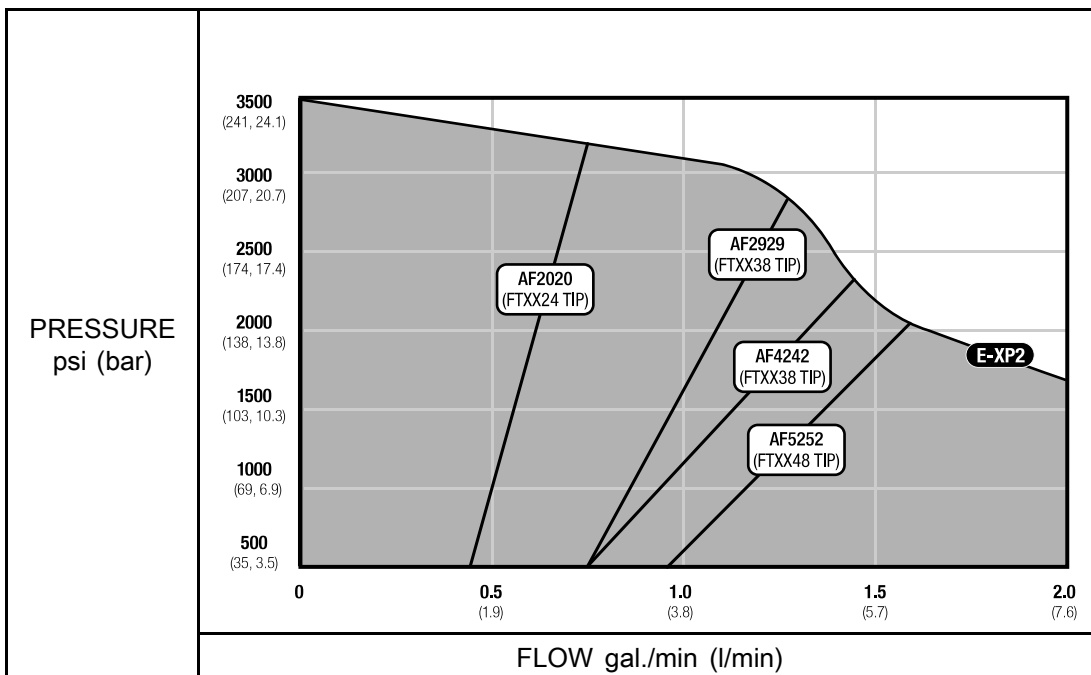

Table 3 Fusion Mechanical Purge, Round Pattern

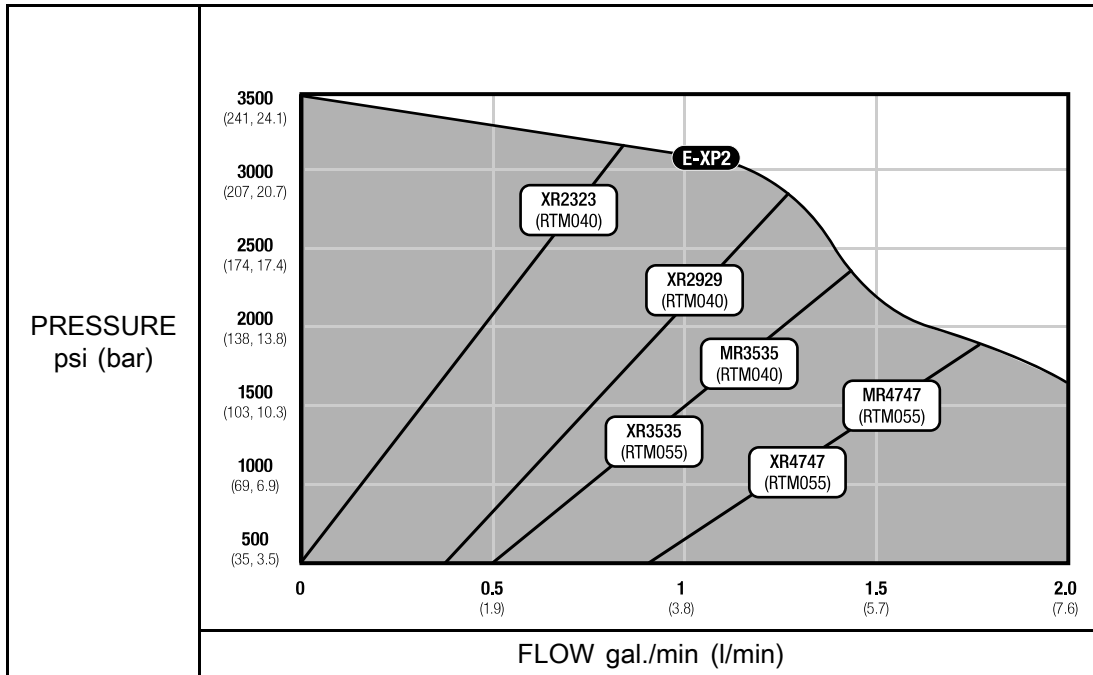
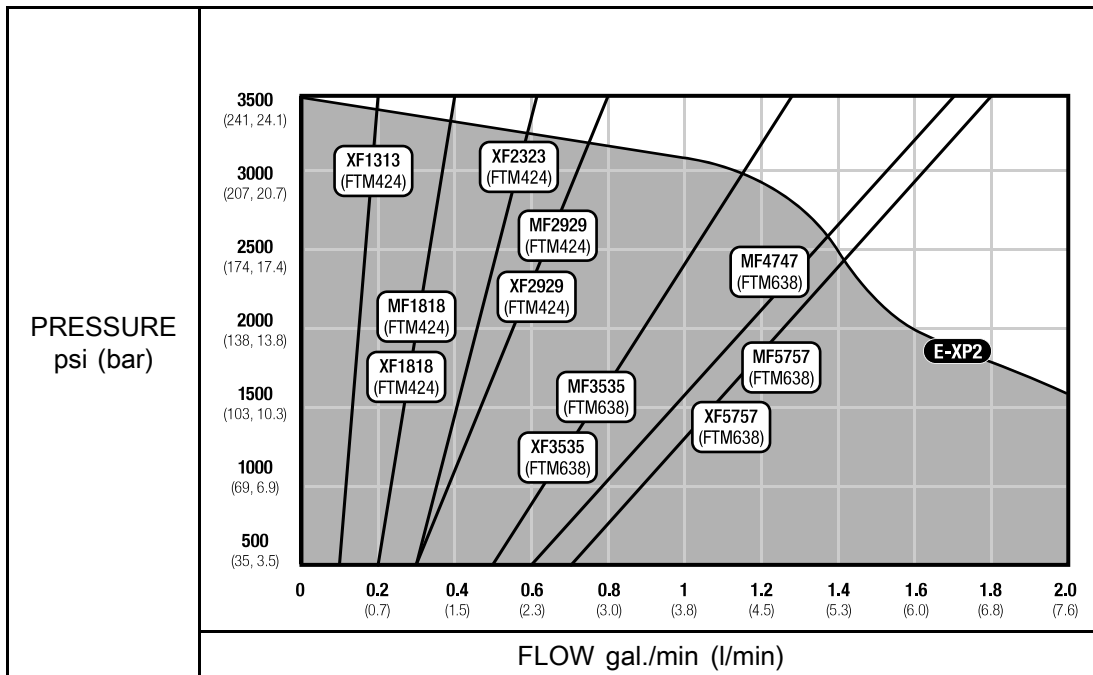

Table 4 Fusion Mechanical Purge, Flat Pattern



Technical Specifications

Reactor 2 E-30 and E-XP2 Proportioning System		
	U.S.	Metric
Maximum Fluid Working Pressure		
E-30	2000 psi	14 MPa, 140 bar
E-XP2	3500 psi	24.1 MPa, 241 bar
Maximum Fluid Temperature		
E-30	190°F	88°C
E-XP2	190°F	88°C
Maximum Flow Rate		
E-30	30 lb/min	13.5 kg/min
E-XP2	2 gpm	7.6 lpm
Maximum Heated Hose Length		
Length	310 ft	94 m
Output per Cycle, ISO and RES		
E-30	0.0272 gal.	0.1034 liter
E-XP2	0.0203 gal.	0.0771 liter
Operating Ambient Temperature Range		
Temperature	20° to 120°F	-7° to 49°C
Line Voltage Requirement		
Nominal 200–240 VAC, 1 Phase, 50/60 Hz	195–265 VAC	
Nominal 200–240 VAC, 3 phase, DELTA, 50/60 Hz	195–265 VAC	
Nominal 350–415 VAC, 3 phase, WYE, 50/60 Hz	340–455 VAC	
Heater Power, (at 230 VAC rated voltage)		
E-30 10 kW	10,200 Watts	
E-30, 15 kW	15,300 Watts	
E-XP2 15 kW	15,300 Watts	

Sound Pressure, Sound Pressure measured per ISO-9614-2.		
E-30, Measured from 3.1 ft (1 m), at 1000 psi (7 MPa, 70 bar), 3 gpm (11.4 lpm)	87.3 dBA	
E-XP2, Measured from 3.1 ft (1 m), at 3000 psi (21 MPa, 207 bar), 1 gpm (3.8 lpm)	79.6 dBA	
Sound Power		
E-30, Measured from 3.1 ft (1 m), at 1000 psi (7 MPa, 70 bar), 3 gpm (11.4 lpm)	93.7 dBA	
E-XP2, Measured from 3.1 ft (1 m), at 3000 psi (21 MPa, 207 bar), 1 gpm (3.8 lpm)	86.6 dBA	
Fluid Inlets		
Component A (ISO) and Component B (RES)	3/4 NPT(f) with 3/4 NPSM(f) union	
Fluid Outlets		
Component A (ISO)	#8 (1/2 in.) JIC, with #5 (5/16 in.) JIC adapter	
Component B (RES)	#10 (5/8 in.) JIC, with #6 (3/8 in.) JIC adapter	
Fluid Circulation Ports		
Size	1/4 NPSM(m)	
Maximum Pressure	250 psi	1.75 MPa, 17.5 bar
Dimensions		
Width	26.3 in.	668 mm
Height	63 in.	1600 mm
Depth	15 in.	381 mm
Weight		
E-30, 10 kW	315 lb	143 kg
E-30, 15 kW	350 lb	159 kg
E-30, 10 kW Elite	320 lb	145 kg
E-30, 15 kW Elite	355 lb	161 kg
E-XP2	345 lb	156 kg
E-XP Elite	350 lb	159 kg
Wetted Parts		
Material	Aluminum, stainless steel, zinc plated carbon steel, brass, carbide, chrome, chemically resistant o-rings, PTFE, ultra-high molecular weight polyethylene	

Graco Extended Warranty for Reactor® 2 Components

Graco warrants all equipment referenced in this document which is manufactured by Graco and bearing its name to be free from defects in material and workmanship on the date of sale to the original purchaser for use. With the exception of any special, extended, or limited warranty published by Graco, Graco will, for a period of twelve months from the date of sale, repair or replace any part of the equipment determined by Graco to be defective. This warranty applies only when the equipment is installed, operated and maintained in accordance with Graco's written recommendations.

Graco Part Number	Description	Warranty Period
24U050 24U051	Electric Motor	36 Months or 3 Million Cycles
24U831	Motor Control Module	36 Months or 3 Million Cycles
24U832	Motor Control Module	36 Months or 3 Million Cycles
24U855	Heater Control Module	36 Months or 3 Million Cycles
24U854	Advanced Display Module	36 Months or 3 Million Cycles
All other Reactor 2 parts		12 Months

This warranty does not cover, and Graco shall not be liable for general wear and tear, or any malfunction, damage or wear caused by faulty installation, misapplication, abrasion, corrosion, inadequate or improper maintenance, negligence, accident, tampering, or substitution of non-Graco component parts. Nor shall Graco be liable for malfunction, damage or wear caused by the incompatibility of Graco equipment with structures, accessories, equipment or materials not supplied by Graco, or the improper design, manufacture, installation, operation or maintenance of structures, accessories, equipment or materials not supplied by Graco.

This warranty is conditioned upon the prepaid return of the equipment claimed to be defective to an authorized Graco distributor for verification of the claimed defect. If the claimed defect is verified, Graco will repair or replace free of charge any defective parts. The equipment will be returned to the original purchaser transportation prepaid. If inspection of the equipment does not disclose any defect in material or workmanship, repairs will be made at a reasonable charge, which charges may include the costs of parts, labor, and transportation.

THIS WARRANTY IS EXCLUSIVE, AND IS IN LIEU OF ANY OTHER WARRANTIES, EXPRESS OR IMPLIED, INCLUDING BUT NOT LIMITED TO WARRANTY OF MERCHANTABILITY OR WARRANTY OF FITNESS FOR A PARTICULAR PURPOSE.

Graco's sole obligation and buyer's sole remedy for any breach of warranty shall be as set forth above. The buyer agrees that no other remedy (including, but not limited to, incidental or consequential damages for lost profits, lost sales, injury to person or property, or any other incidental or consequential loss) shall be available. Any action for breach of warranty hereunder must be brought within the latter of two (2) years of the date of sale, or one (1) year the warranty period expires.

GRACO MAKES NO WARRANTY, AND DISCLAIMS ALL IMPLIED WARRANTIES OF MERCHANTABILITY AND FITNESS FOR A PARTICULAR PURPOSE, IN CONNECTION WITH ACCESSORIES, EQUIPMENT, MATERIALS OR COMPONENTS SOLD BUT NOT MANUFACTURED BY GRACO. These items sold, but not manufactured by Graco (such as electric motors, switches, hose, etc.), are subject to the warranty, if any, of their manufacturer. Graco will provide purchaser with reasonable assistance in making any claim for breach of these warranties.

In no event will Graco be liable for indirect, incidental, special or consequential damages resulting from Graco supplying equipment hereunder, or the furnishing, performance, or use of any products or other goods sold hereto, whether due to a breach of contract, breach of warranty, the negligence of Graco, or otherwise.

FOR GRACO CANADA CUSTOMERS

The Parties acknowledge that they have required that the present document, as well as all documents, notices and legal proceedings entered into, given or instituted pursuant hereto or relating directly or indirectly hereto, be drawn up in English. Les parties reconnaissent avoir convenu que la rédaction du présente document sera en Anglais, ainsi que tous documents, avis et procédures judiciaires exécutés, donnés ou intentés, à la suite de ou en rapport, directement ou indirectement, avec les procédures concernées.

Graco Information

For the latest information about Graco products, visit www.graco.com.

To place an order, contact your Graco Distributor or call to identify the nearest distributor.

Phone: 612-623-6921 **or Toll Free:** 1-800-328-0211 **Fax:** 612-378-3505

All written and visual data contained in this document reflects the latest product information available at the time of publication.

Graco reserves the right to make changes at any time without notice.

For patent information, see www.graco.com/patents.

Original Instructions. This manual contains English. MM 333024

Graco Headquarters: Minneapolis

International Offices: Belgium, China, Japan, Korea

GRACO INC. AND SUBSIDIARIES • P.O. BOX 1441 • MINNEAPOLIS MN 55440-1441 • USA

Copyright 2014, Graco Inc. All Graco manufacturing locations are registered to ISO 9001.

www.graco.com

Revision J, September 2016